

VIVAX

VRF catalogue



High efficiency

Advanced technology

High comfort

Easy installation

Contents

PRODUCT LINE UP

Outdoor units	6
Indoor units	8
VMV 5	10
VMV 5H	30
VMV 5R	46
VMV S	64
AHU KIT	74
VMV Indoor Units	80
VMV Indoor ventilation	122
Control system	126
Reference projects	138

Why VIVAX VRF?

High efficiency

VIVAX VRF systems are equipped with a new four-way heat exchanger which has increased heat transfer efficiency due to a larger heat exchange area and together with a DC Inverter technology, refrigerant sub-cooling and innovative compressor design contribute to high-efficiency performance and low operation costs of the VIVAX VRF systems.

Advanced technology

VIVAX VRF systems have a full DC inverter compressor and a DC fan motor with stepless speed control which enable precise control and power input reduction. VMV 5H outdoor units use enhanced vapor injection compressors and refrigerant sub-cooling technology.

High comfort

VIVAX VRF indoor units are equipped with a DC fan motor with a wide range of fan speed and could easily be adapted to the user needs. Systems have a wide range of control solutions from infra-red and wired controllers, central control, smart WI-FI control through a mobile app, to various bms solutions through the Modbus, BACnet, KNX and Lonworks protocols. Outdoor temperature operation range from -27 °C in heating and up to 52 °C in cooling makes VIVAX VRF systems capable to fit in almost any design.

Easy installation

The outdoor unit can automatically address the indoor units through the module on the PCB. It is more convenient and time saving as there is no need to manually set the addresses on each indoor units separately. Rotating design of the electronic control box allows easy access to all internal system components, and saves time during maintenance. Refrigerant pipes can be connected from four different directions which makes the piping installation simpler while saving time and material.

VIVAX. FOREVER.

2017

It was developed an air conditioner that works at outdoor temperature of -32 °C, both during heating and cooling mode. 73 different air conditioners in the offer.

2018

The seventh generation of multi-split air conditioners. The sixth generation of commercial air conditioners. Best Buy Award 2018 / 2019.

2019

Popular R Design in new colours. R32 gas in all air conditioners. Corrosion protection agent in outdoor units. Qudal Award 2019 / 2020.

2020

The first generation of heat pumps.

2021

Present in more than 35 countries.

2022

90 different airconditioners in the offer.

2023

Expansion of the air conditioning range to VRF air conditioning systems.

2024

VIVAX
20
YEARS

We are proudly celebrating 20 years, always striving not only provide top quality products, but also a memorable experience.

2004

First VIVAX air conditioners on the market.

2006

The first multi-splits and the first accessories for air conditioners.

2008

The second generation of commercial and multi-split air conditioners.

2013

The fourth generation of multi-split air conditioners. The third generation of commercial air conditioners.

2015

The fifth generation of multi-split air conditioners. The fourth generation of commercial air conditioners. The first Wi-Fi air conditioners, 61 devices in the offer.

2005

First inverter, mobile and cassette air conditioners.

2007

The first floor-ceiling air conditioner.

2011

The third generation of multi-split air conditioners.

2014

Super free match system was introduced. 59 air conditioners in the offer.

2016

The sixth generation of multi-split air conditioners. The fifth generation of commercial air conditioners. 65 different air conditioners in the offer.

Present in **more than 35** countries

Already 20 years users in **over 35 markets** have had trust in VIVAX air conditioners.



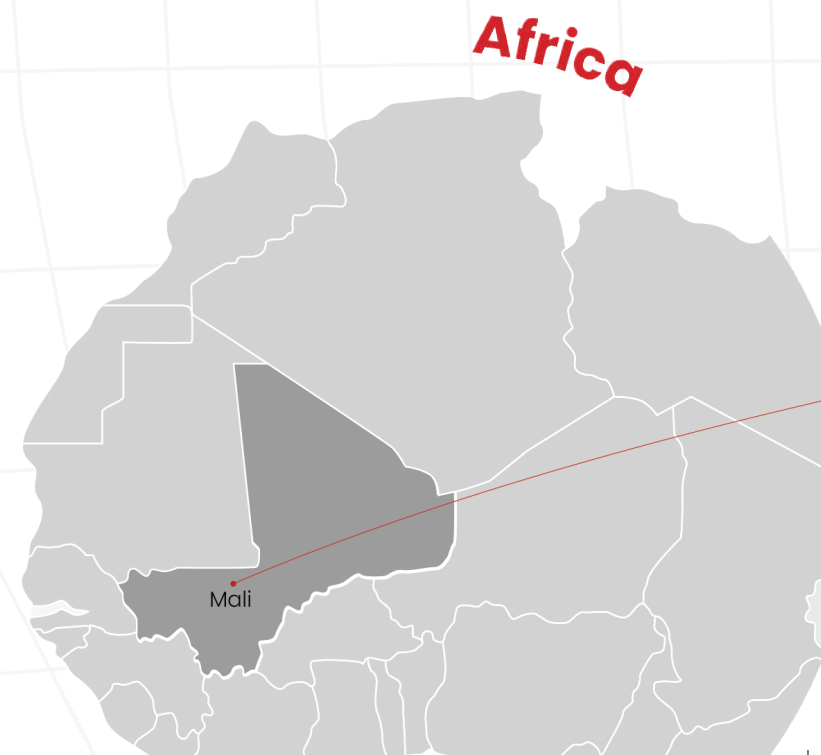

Top quality and timeless design have found their way to many homes, which, thanks to the VIVAX air conditioners and regardless of the season, are always at the optimum temperature.









Product line up – Outdoor units

Series	HP	8	10	12	14	16	18	20	22	24	26	28	30	32	34	36	38	40	42	44	46	48	50	52
	Kw	25.2	28.0	33.5	40.0	45.0	50.4	56.0	61.5	68.0	73.5	80.0	85.0	90.0	95.4	100.8	106.4	112.0	117.5	123.0	129.5	136.0	141.5	147.0
VMV 5	3/380~415/50																							
	3/380~415/60																							
VMV 5H	3/380~415/50																							
	3/380~415/60																							
VMV 5R	3/380~415/50																							
	3/380~415/60																							

Series	HP	4	5	6	8	10	12
	kW	12.1	14.0	15.5	22.6	28.0	31.5
VMV S	1/220~240/50 1/220~240/60						
	1/220~240/50 1/220~240/60						
	3/380~415/50 3/380~415/60						
	3/380~415/50 3/380~415/60						







52	54	56	58	60	62	64	66	68	70	72	74	76	78	80	82	84	86	88	90	92	94	96	98	100	102	104
47.0	151.2	156.8	162.4	168.0	173.5	179.0	184.5	191.0	197.5	204.0	209.5	215.0	220.5	224.0	229.5	235.0	240.5	246.0	252.5	259.0	265.5	272.0	277.5	283.0	288.5	294.0



Model	VAH-01REA1	VAH-02REA1	VAH-03REA1	VAH-04REA1	VAH-05REA1
Capacity	$3.5 \leq X \leq 7.0$ kW	$7.0 \leq X \leq 14.0$ kW	$14.0 \leq X \leq 28.0$ kW	$28.0 \leq X \leq 56.0$ kW	$56.0 \leq X \leq 73.0$ kW
					
VMV series	VMV 5, VMV S (4/5/6/8/10/12 HP Double fan)				

Product line up – Indoor units

Series	KBTU/h		5	7	9	12	16	18	24	28	30	38	42	48	54	72	96
	kW		1.5	2.2	2.8	3.6	4.5	5.6	7.1	8.0	9.0	11.2	12.5	14.0	16.0	22.6	28.0
One-Way Cassette		IMV-***C1AREDA	●	●	●	●	●	●	●								
Two-Way Cassette		IMV-***C2AREDA			●	●	●	●	●	●	●	●	●	●			
Compact Four-Way Cassette		IMV-***CCAREDA	●	●	●	●	●	●									
Round Flow Cassette		IMV-***C4AREDA		●	●	●	●	●	●	●	●	●		●	●		
Floor-Ceiling		IMV-***CFAREDA				●	●	●	●	●	●	●		●			
Slim Duct		IMV-***DTLAREDA	●	●	●	●	●	●	●	●							
High Static Pressure Duct		IMV-***DTHAREDA	●	●	●	●	●	●	●	●	●	●		●	●		

Series	KBTU/h		5	7	9	12	16	18	24	28	30	38	42	48	54	72	96
	kW		1.5	2.2	2.8	3.6	4.5	5.6	7.1	8.0	9.0	11.2	12.5	14.0	16.0	22.6	28.0
High ESP Duct		IMV-***DTHAREDA														•	•
Built in floor standing		IMV-***CTCAREAA		•	•	•	•	•	•								
Console		IMV-***CTAREDA	•	•	•	•	•	•									
High Wall		IMV-***CHAREDA IMV-***CHAREDAV	•	•	•	•	•	•	•	•	•						
		IMV-***CHDAREDA IMV-***CHDAREDAV	•	•	•	•	•	•	•								
Fresh air duct		IMV-***FAAREDF												•		•	•
Hydro box									•					•			•



VMV5

DC INVERTER



Advanced technology



High efficiency



Super comfort



Easy installation

Advanced technology

Flexible long piping design

- 1000 m maximum total piping length
- 220 m maximum actual piping length
- 110 m / 90 m maximum height difference between ODU and IDU (ODU higher / IDU higher)
- 30 m maximum height difference between IDU and IDU

* For the total piping length between 300 m and 1000 m, and height difference greater than 50 m please contact your supplier

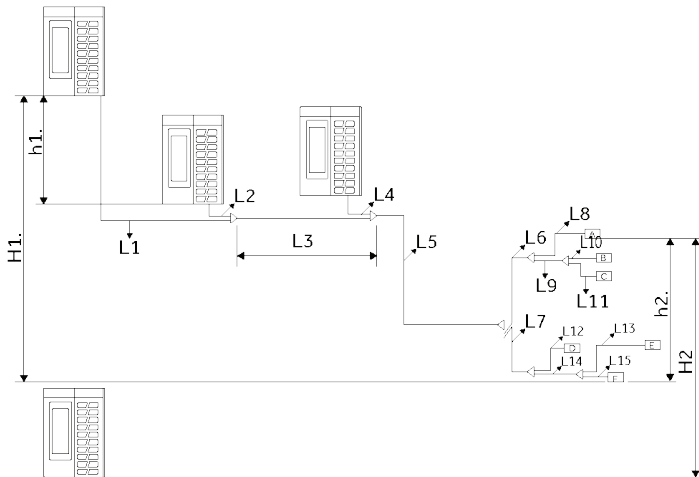
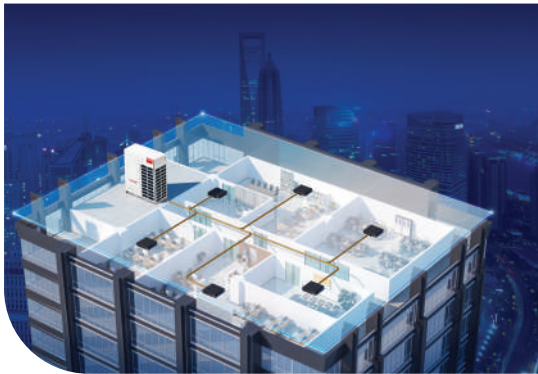

Optimized condenser coil design

The condenser coil is split in half and refrigerant flow through each part is independently controlled by the separate electronic expansion valve. In this way refrigerant flow and heat exchange area are always optimized to match the indoor units load demand, thus increasing the heat exchange efficiency and improving the system performance.

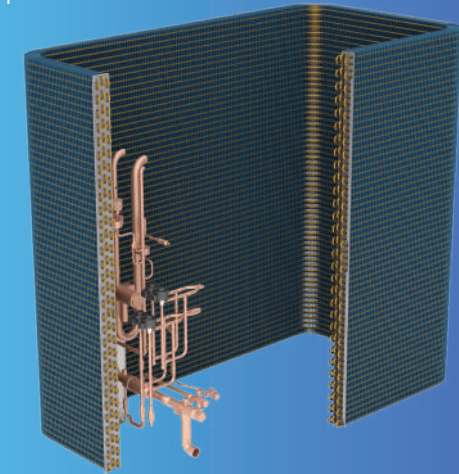

	Max. length	Pipe in left figure	
Single way total pipe length (=total liquid pipe length)	1000 m	L1 + L2 + L3 + L4 + L5 + L6 + L7 + L8 + L9 + L10 + L11 + L12 + L13 + L14 + L15	
Single way max. pipe length (max. length between outdoor & indoor) actual length	220 m	L1 + L3 + L5 + L7 + L14 + L13	
Main pipe actual length (length between first gather pipe & first branch pipe)	130 m	L5	
Pipe length after first branch pipe (length between first branch & farthest indoor)	90 m	L7 + L13 + L14	
The distance between the nearest indoor unit and the farthest indoor	40 m	L13 + L14 - L12	
Pipe length among outdoor units (length between first gather pipe & farthest outdoor unit)	10 m	L1 + L3	
Height difference between indoors	18 m	h2	
Height difference between outdoors	5 m	h1	
Height difference between indoor & outdoor	Indoor below outdoor (between highest outdoor & lowest indoor)	50 m	H1
	Indoor above outdoor (between lowest outdoor & highest indoor)	40 m	H2

High efficiency

Increased efficiency with full DC inverter compressor

Exhaust temperature sensor

1 Soft scroll plate design, compared with the common scroll plate, it reduce the leakage loss and mechanical loss, more efficiency.

2 The soft structure and overpressure protection of unloading valve, both of them can effectively reduce stress loss. The compressor is more stable and also efficiency.

3 We adopted High pressure chamber compressor, and low oil rate structure design, to ensure the reliable oil supply of the compressor, and lubricate all parts effectively.

4 Integrated design of support and shell, to ensure the compressor running stably.

5 Three stage oil return inside the compressor:
 • Gravity oil return
 • Centrifugal oil return
 • Structure shelter oil return

6 Adopt new type oil cup design, reduce the disturbance of high speed rotation to oil level, also reduce the oil discharge, improve lubrication efficiency, reduce frictional loss.

Oil temperature sensor

Matches up inverter with stepless compressor, the durability and stability of the compressor are guaranteed, fault can be reduced.

Each compressor is adopted oil temperature sensor and the discharge temperature sensor, detecting the discharge temperature and oil temperature of compressor, cooperated with the compressor frequency and the EEV control, to ensure exhaust heat and oil temperature superheat kept within the optimal range. Ensure that the oil dilution is maintained at a safe level at all times.

DC inverter stepless fan motor

The outdoor fan motor has stepless inverter regulation technology and is able to operate in the 0-91 Hz frequency range which increases efficiency. stepless frequency.

Temperature approaching technology

The main problem of an ordinary inverter VRF system lies in that its compressor starts and stops frequently, stopping when the room temperature reaches the setting temperature and restarting when the same becomes higher than the setting temperature. Though the inverter technology has improved such a problem greatly, the energy consumption caused by system restart is still a problem that cannot be ignored. VMV 5 series units adopts the temperature approaching technology, which enables the VRF system to maintain a low-frequency operating state all the time when the room temperature is close to the setting temperature but doesn't reach the setting temperature, thus avoiding the energy waste caused by frequent on / off.

New four-way heat exchanger

Common three-way heat exchanger

VS

30%
HEAT TRANSFER EFFICIENCY INCREASED BY

VIVAX new four-way heat exchanger

High comfort



Wide operation temperature range

The operation in heating and cooling are improved and temperature limits are -23 °C in heating and 50 °C in cooling.

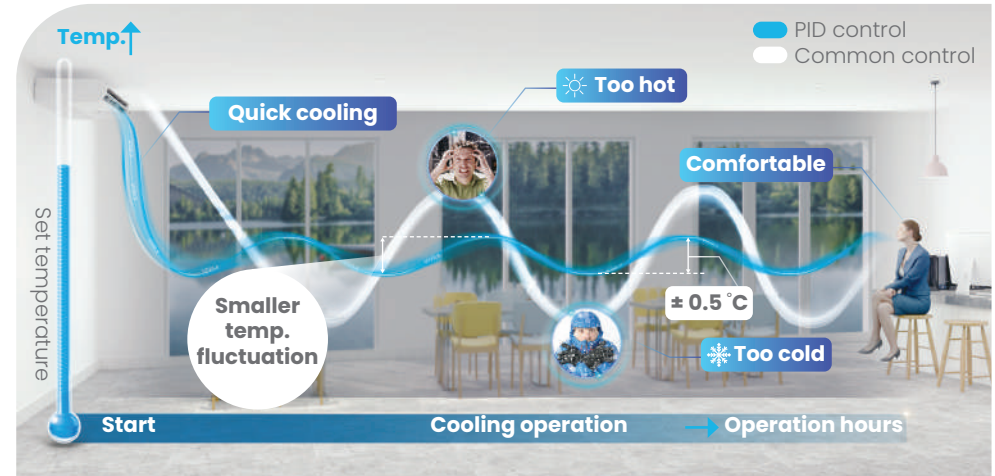

Precise temperature control

The VMV 5 units are equipped with double pressure sensors and double electronic expansion valves which enable the automatic refrigerant volume adjustment. With this technology indoor temperature could be controlled by 0.5 °C steps improving the comfort.

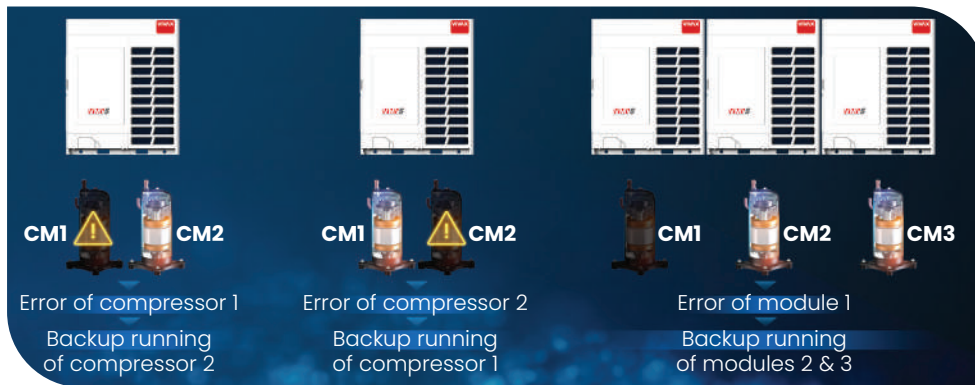

Intelligent backup operation technology

In the case of a compressor malfunction another compressor (single outdoor unit with two compressors) or outdoor unit (multi module outdoor system) will enter in the backup operation. Units will continue to operate for 8 hours allowing the time for repair while providing the indoor comfort.

Easy Installation

Four-way refrigerant piping connection

Refrigerant pipes can be connected from four different directions which makes the piping installation simpler while saving time and material.

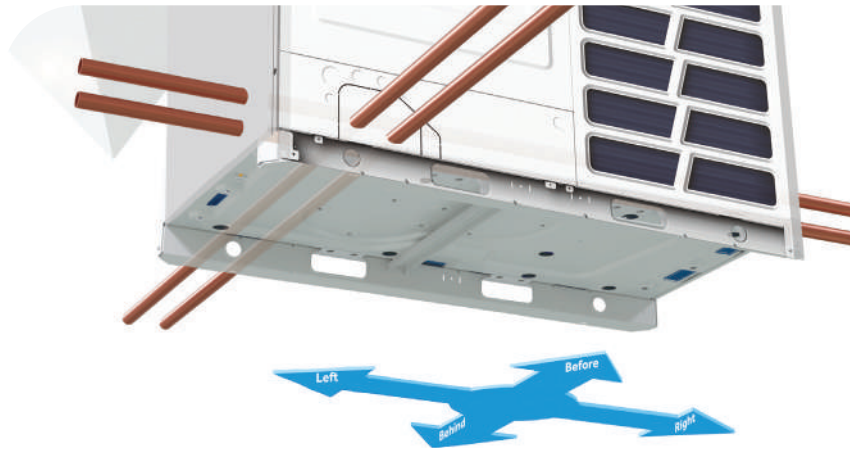

110 Pa external static pressure

External static pressure of outdoor unit air outlet can be set up to 110 Pa which allows multiple installation options.



Installation of duct

The outdoor unit is hidden inside the building without affecting the overall image of the building

Auto addressing indoor units

The outdoor unit can automatically address the indoor units through the module on the PCB. It is more convenient and time saving as there is no need to manually set the addresses on each indoor units separately.



Automatic oil balancing

In the multi module outdoor system the oil level in every module is balanced automatically. In such system there is no need for oil balancing pipes which simplifies the system design and improves reliability.



Automatic snow and dust removal

The outdoor unit has the function of preventing snow accumulation on top of the unit. The dust can be blown away from the outdoor heat exchanger by reversing the operation of the fan.



Night time low noise operation mode

It is possible to set the low noise operation mode which reduces the sound level by 10 dB(A). This function is useful when units are installed in residential areas, as well as in other noise-sensitive places.

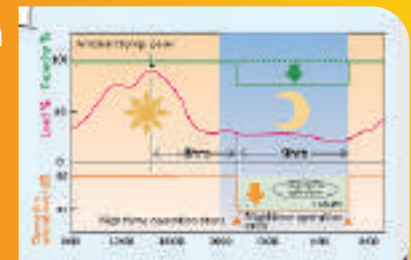

Dimensions

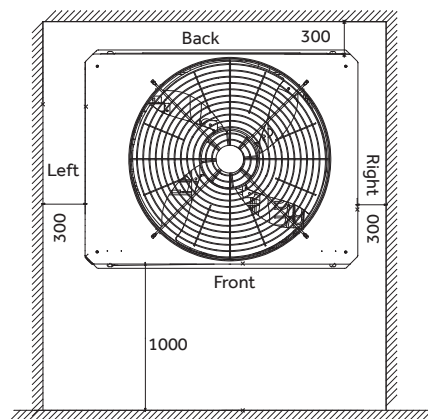
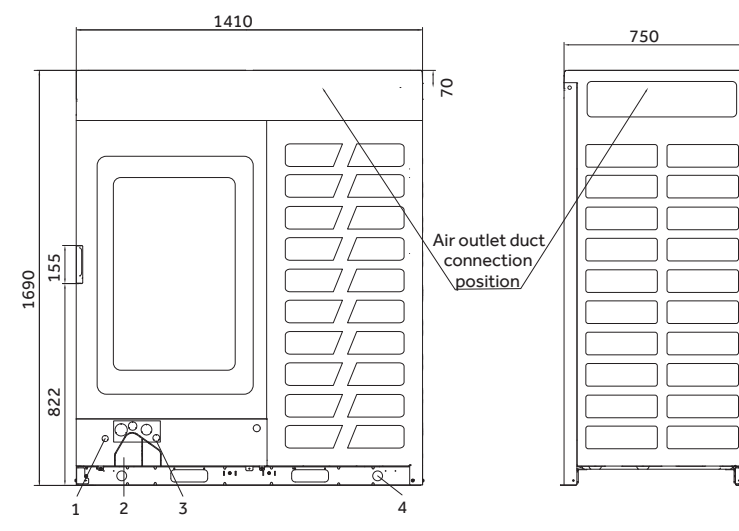
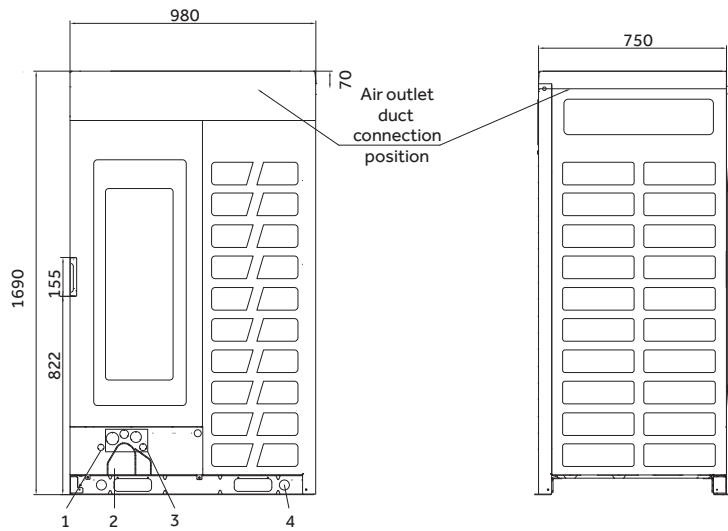
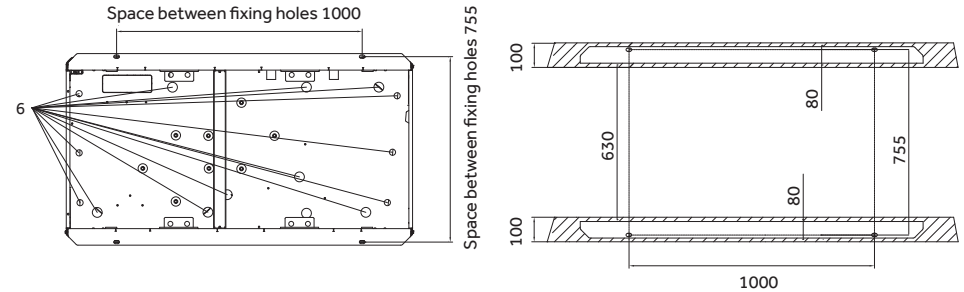
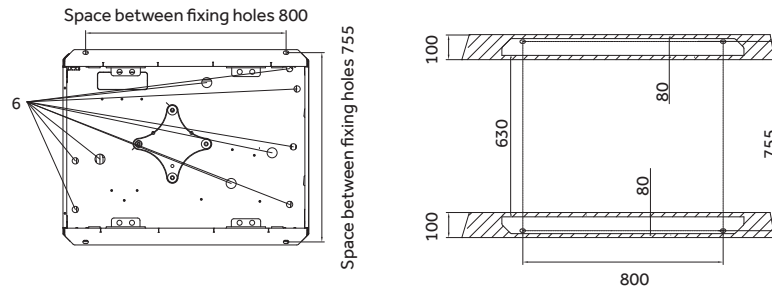

No.	Name	Remark
1	Signal line hole Ø25	Using the rubber plug in the unit's attachment for protection
2	Pipe outlet for 2-pipe system	
3	Power supply hole	According to the wire diameter size to choose the appropriate line hole, and using the line sheath in the unit's attachment for protection
4	Hoisting hole	
5	Power supply of signal line hole	
6	Drain hole	

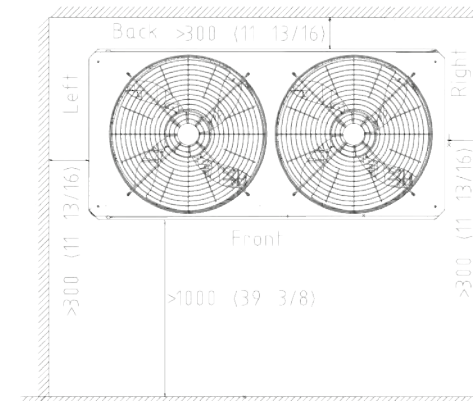

No.	Name	Remark
1	Signal line hole Ø25	Using the rubber plug in the unit's attachment for protection
2	Pipe outlet for 2-pipe system	
3	Pipe outlet for 3-pipe system	
4	Power supply hole	According to the wire diameter size to choose the appropriate line hole, and using the line sheath in the unit's attachment for protection
5	Hoisting hole	
6	Power supply of signal line hole	
7	Refrigerant pipe outlet	
8	Drain hole	

Model		VMV-252ARETA3	VMV-280ARETA3	VMV-335ARETA3	VMV-400ARETA3	VMV-450ARETA3	
Combination model		-	-	-	-	-	
		-	-	-	-	-	
		-	-	-	-	-	
		-	-	-	-	-	
Capacity	Capacity range (HP)	8	10	12	14	16	
	Cooling (kW)	25.2	28.0	33.5	40.0	45.0	
	Heating (kW)	25.2	28.0	33.5	40.0	45.0	
	Heating - Max. (kW)	28.00	31.50	37.50	45.00	50.00	
Electrical parameters	Power supply (Ph/V/Hz)	3/380-415/50/60					
	Cooling	Rated power input (kW)	6.24	7.37	10.15	11.94	13.24
		Max power input (kW)	10.08	11.56	13.80	16.40	19.20
		Rated current (A)	10.53	12.44	17.14	20.16	22.34
		Max current (A)	17.02	19.52	23.30	27.69	32.41
	Heating	Rated power input (kW)	5.7	6.5	8.6	10.0	11.3
		Max power input (kW)	9.90	11.25	12.50	15.10	18.40
		Rated current (A)	9.67	10.99	14.52	16.88	18.99
		Max current (A)	16.71	18.99	21.10	25.49	31.06
	SEER	7.25	7.09	6.69	6.60	6.36	
	SCOP	4.41	4.31	4.31	4.12	4.05	
	ηs,c (%)	287	281	265	261	251	
	ηs,c (%)	173	169	169	162	159	
Performance	Air flow (m³/h)	11000.00	11000.00	12000.00	13500.00	13500.00	
	Sound pressure level (dB(A))	56	56	59	59	60	

3/380~415/50/60



Total pipe length 1000 m, height drop 110 m



Auto addressing indoor units



Space saving



Better cooling capacity



VMV-252ARETA3
VMV-280ARETA3
VMV-335ARETA3
VMV-400ARETA3
VMV-450ARETA3



VMV-504ARETA3
VMV-560ARETA3
VMV-615ARETA3
VMV-680ARETA3
VMV-735ARETA3

Model		VMV-252ARETA3	VMV-280ARETA3	VMV-335ARETA3	VMV-400ARETA3	VMV-450ARETA3
Installation	External dimensions - W/D/H (mm)	980/1690/750	980/1690/750	980/1690/750	980/1690/750	980/1690/750
	Shipping dimensions - W/D/H (mm)	1070/1858/850	1070/1858/850	1070/1858/850	1070/1858/850	1070/1858/850
	Net/Shipping weight (kg)	224/250			244/270	
	Compressor type	DC INV. SCROLL				
	Compressor quantity	11NV				
	Refrigerant type	R410A				
	Refrigerant charge (kg)	8.5	8.5	8.5	10.0	10.0
	Refrigerant liquid pipe (mm)	9.52	9.52	12.70	12.70	12.70
	Refrigerant gas pipe (mm)	19.05	22.22	25.40	25.40	28.58
	Max.total pipe lenth (m)	1000	1000	1000	1000	1000
	Max. pipe length (Equivalent/Actual)	260/220	260/220	260/220	260/220	260/220
	Max drop between I.U. & O.U. (O.U. down/up) *1 (m)	110/90	110/90	110/90	110/90	110/90
	Standard drop between I.U. & O.U. (O.U. up/down) *2 (m)	50/40	50/40	50/40	50/40	50/40
	Max drop between I.U. *3 (m)	30	30	30	30	30
	Standard drop between I.U. *4 (m)	18	18	18	18	18
External static pressure (Pa)	110	110	110	110	110	
Connection ratio	Connectable indoor unit ratio (%)	50-130				
	Maximum number of indoor units	13	16	20	24	27
Working temp.	Cooling (°C)	-5-50				
	Heating (°C)	-23-21				

Max drop between I.U. & O.U *1 - If the height difference between the outdoor and the indoor units is from 50 to 110 m, contact your local distributor / dealer for individual design and production.

Standard drop between I.U. & O.U *2 - Standard design and production in the factory.

Max drop between I.U. *3 - If the height difference between the indoor units is from 18 to 30 m, contact your local distributor/dealer for individual design and production.

Standard drop between I.U. *4 - Standard design and production in the factory.

* All the specifications are tested under nominal condition (in cooling, indoor temp. is 27 °C DB / 19 °C WB; Outdoor temp. 35 °C DB / 24 WB; in heating, indoor temp. is 20 °C DB, in heating, outdoor temp. is 7 °C DB / 6 °C WB).

Model		VMV-504ARETA3	VMV-560ARETA3	VMV-615ARETA3	VMV-680ARETA3	VMV-735ARETA3	VMV-800ARETA3	VMV-850ARETA3	VMV-900ARETA3	
Combination model		-	-	-	-	-	VMV-400ARETA3	VMV-400ARETA3	VMV-450ARETA3	
		-	-	-	-	-	VMV-400ARETA3	VMV-450ARETA3	VMV-450ARETA3	
		-	-	-	-	-	-	-	-	
		-	-	-	-	-	-	-	-	
Capacity	Capacity range (HP)	18	20	22	24	26	28	30	32	
	Cooling (kW)	50.4	56.0	61.5	68.0	73.5	80.0	85.0	90.0	
	Heating (kW)	50.4	56.0	61.5	68.0	73.5	80.0	85.0	90.0	
	Heating - Max. (kW)	56.50	61.50	69.00	73.00	82.50	90.0	95.0	100.0	
Electrical parameters	Power supply (Ph/V/Hz)	3/380-415/50/60								
	Cooling	Rated power input (kW)	15.60	16.62	20.16	22.67	27.22	23.88	25.18	26.47
		Max power input (kW)	21.40	25.10	28.50	29.10	37.80	32.80	35.60	38.40
		Rated current (A)	26.34	28.05	34.06	38.27	45.96	40.32	42.50	44.69
		Max current (A)	36.13	42.37	48.11	49.13	61.91	55.37	60.10	64.83
	Heating	Rated power input (kW)	13.2	14.7	18.6	19.4	26.3	20.0	21.3	22.5
		Max power input (kW)	17.70	22.70	25.50	26.50	30.40	30.20	33.50	36.80
		Rated current (A)	22.27	24.75	31.49	32.80	45.68	33.8	35.9	38.0
		Max current (A)	29.88	38.32	43.05	44.74	51.32	50.98	56.55	62.13
	SEER	6.78	6.75	6.54	5.83	4.90	6.60	6.36	6.36	
	SCOP	4.15	4.20	4.21	4.17	3.50	4.12	4.05	4.05	
	$\eta_{s,c}$ (%)	268	267	259	230	193	261	251	251	
$\eta_{s,c}$ (%)	163	165	165	164	137	162	159	159		
Performance	Air flow (m ³ /h)	17000.00	17000.00	18000.00	18000.00	19000.00	27000.00	27000.00	27000	
	Sound pressure level (dB(A))	61	61	61	62	62	62	63	63	

3/380~415/50/60



Total pipe length 1000 m, height drop 110 m



Auto addressing indoor units



Space saving



Better cooling capacity



VMV-252ARETA3
VMV-280ARETA3
VMV-335ARETA3
VMV-400ARETA3
VMV-450ARETA3



VMV-504ARETA3
VMV-560ARETA3
VMV-615ARETA3
VMV-680ARETA3
VMV-735ARETA3

Model		VMV-504ARETA3	VMV-560ARETA3	VMV-615ARETA3	VMV-680ARETA3	VMV-735ARETA3	VMV-800ARETA3	VMV-850ARETA3	VMV-900ARETA3	
Installation	External dimensions - W/D/H (mm)	1410/1690/750					980/1690/750 + 980/1690/750			
	Shipping dimensions - W/D/H (mm)	1515/1858/850					1070/1858/850 + 1070/1858/850			
	Net/Shipping weight (kg)	287/317	370/400				244/270 + 244/270			
	Compressor type	DC INV. SCROLL								
	Compressor quantity	1INV					2INV			
	Refrigerant type	R410A								
	Refrigerant charge (kg)	10.0	10.0	10.0	10.0	10.0	20.0	20.0	20.0	
	Refrigerant liquid pipe (mm)	15.88	15.88	15.88	15.88	15.88	15.88	19.05	19.05	
	Refrigerant gas pipe (mm)	28.58	28.58	28.58	28.58	28.58	28.58	31.8	31.8	
	Max.total pipe length (m)	1000								
	Max. pipe length (Equivalent/Actual)						260/220			
	Max drop between I.U. & O.U. (O.U. down/up) *1 (m)						110/90			
	Standard drop between I.U. & O.U. (O.U. up/down) *2 (m)						50/40			
	Max drop between I.U. *3 (m)						30			
	Standard drop between I.U. *4 (m)						18			
External static pressure (Pa)	110									
Connection ratio	Connectable indoor unit ratio (%)	50-130								
	Maximum number of indoor units	30	33	36	40	43	47	50	53	
Working temp.	Cooling (°C)	-5-50								
	Heating (°C)	-23-21								

Max drop between I.U. & O.U *1 - If the height difference between the outdoor and the indoor units is from 50 to 110 m, contact your local distributor / dealer for individual design and production.

Standard drop between I.U. & O.U *2 - Standard design and production in the factory.

Max drop between I.U. *3 - If the height difference between the indoor units is from 18 to 30 m, contact your local distributor/dealer for individual design and production.

Standard drop between I.U. *4 - Standard design and production in the factory.

* All the specifications are tested under nominal condition (in cooling, indoor temp. is 27 °C DB / 19 °C WB; Outdoor temp. 35 °C DB / 24 WB; in heating, indoor temp. is 20 °C DB, in heating, outdoor temp. is 7 °C DB / 6 °C WB).

Model		VMV-954ARETA3	VMV-1008ARETA3	VMV-1064ARETA3	VMV-1120ARETA3	VMV-1175ARETA3	VMV-1230ARETA3	VMV-1295ARETA3	
Combination model		VMV-450ARETA3	VMV-504ARETA3	VMV-504ARETA3	VMV-560ARETA3	VMV-560ARETA3	VMV-615ARETA3	VMV-615ARETA3	
		VMV-504ARETA3	VMV-504ARETA3	VMV-560ARETA3	VMV-560ARETA3	VMV-615ARETA3	VMV-615ARETA3	VMV-680ARETA3	
		-	-	-	-	-	-	-	
		-	-	-	-	-	-	-	
Capacity	Capacity range (HP)	34	36	38	40	42	44	46	
	Cooling (kW)	95.4	100.8	106.4	112.0	117.5	123.0	129.5	
	Heating (kW)	95.4	100.8	106.4	112.0	117.5	123.0	129.5	
	Heating - Max. (kW)	106.5	113.0	118.0	123.0	130.5	138.0	142.0	
Electrical parameters	Power supply (Ph/V/Hz)	3/380~415/50/60							
	Cooling	Rated power input (kW)	28.84	31.21	32.22	33.23	36.78	40.32	42.83
		Max power input (kW)	40.60	42.80	46.50	50.20	53.60	57.00	57.60
		Rated current (A)	48.69	52.68	54.40	56.11	62.11	68.12	72.33
		Max current (A)	68.54	72.26	78.50	84.75	90.49	96.23	97.24
	Heating	Rated power input (kW)	24.4	26.4	27.9	29.3	33.3	37.3	38.1
		Max power input (kW)	36.10	35.40	40.40	45.40	48.20	51.00	52.00
		Rated current (A)	41.3	44.5	47.0	49.5	56.2	63.0	64.3
		Max current (A)	60.94	59.76	68.20	76.64	81.37	86.10	87.79
	SEER	6.36	6.78	6.75	6.75	6.54	6.54	5.83	
	SCOP	4.05	4.15	4.15	4.2	4.2	4.21	4.17	
	ηs,c (%)	251	268	267	267	259	259	230	
ηs,c (%)	159	163	163	165	165	165	164		
Performance	Air flow (m³ / h)	30500	34000	34000	34000	35000	36000	36000	
	Sound pressure level (dB(A))	64	64	64	64	64	64	65	

3/380~415/50/60



Total pipe length 1000 m, height drop 110 m



Auto addressing indoor units



Space saving



Better cooling capacity



VMV-252ARETA3
VMV-280ARETA3
VMV-335ARETA3
VMV-400ARETA3
VMV-450ARETA3



VMV-504ARETA3
VMV-560ARETA3
VMV-615ARETA3
VMV-680ARETA3
VMV-735ARETA3

Model		VMV-954ARETA3	VMV-1008ARETA3	VMV-1064ARETA3	VMV-1120ARETA3	VMV-1175ARETA3	VMV-1230ARETA3	VMV-1295ARETA3
Installation	External dimensions - W/D/H (mm)	980/1690/750 + 1410/1690/750	1410/1690/750 + 1410/1690/750					
	Shipping dimensions - W/D/H (mm)	1070/1858/850 + 1515/1858/850	1515/1858/850 + 1515/1858/850					
	Net/Shipping weight (kg)	244/270 + 287/317	287/317 + 287/317		370/400 + 370/400			
	Compressor type	DC INV. SCROLL						
	Compressor quantity	2INV	2INV	3INV	4INV	4INV	4INV	4INV
	Refrigerant type	R410A						
	Refrigerant charge (kg)	20	20	20	20	20	20	20
	Refrigerant liquid pipe (mm)	19.05	19.05	19.05	19.05	19.05	19.05	19.05
	Refrigerant gas pipe (mm)	31.8	38.1	38.1	38.1	38.1	38.1	38.1
	Max.total pipe length (m)	1000						
	Max. pipe length (Equivalent/Actual)	260/220						
	Max drop between I.U. & O.U. (O.U. down/up) *1 (m)	110/90						
	Standard drop between I.U. & O.U. (O.U. up/down) *2 (m)	50/40						
	Max drop between I.U. *3 (m)	30						
Standard drop between I.U. *4 (m)	18							
External static pressure (Pa)	110							
Connection ratio	Connectable indoor unit ratio (%)	50-130						
	Maximum number of indoor units	56	59	63	64	64	64	64
Working temp.	Cooling (°C)	-5-50						
	Heating (°C)	-23-21						

Max drop between I.U. & O.U *1 - If the height difference between the outdoor and the indoor units is from 50 to 110 m, contact your local distributor / dealer for individual design and production.

Standard drop between I.U. & O.U *2 - Standard design and production in the factory.

Max drop between I.U. *3 - If the height difference between the indoor units is from 18 to 30 m, contact your local distributor/dealer for individual design and production.

Standard drop between I.U. *4 - Standard design and production in the factory.

* All the specifications are tested under nominal condition (in cooling, indoor temp. is 27 °C DB / 19 °C WB; Outdoor temp. 35 °C DB / 24 °C WB; in heating, indoor temp. is 20 °C DB, in heating, outdoor temp. is 7 °C DB / 6 °C WB).

Model		VMV-1360ARETA3	VMV-1415ARETA3	VMV-1470ARETA3	VMV-1512ARETA3	VMV-1568ARETA3	VMV-1624ARETA3	VMV-1680ARETA3	
Combination model		VMV-680ARETA3	VMV-680ARETA3	VMV-735ARETA3	VMV-504ARETA3	VMV-504ARETA3	VMV-504ARETA3	VMV-560ARETA3	
		VMV-680ARETA3	VMV-735ARETA3	VMV-735ARETA3	VMV-504ARETA3	VMV-504ARETA3	VMV-560ARETA3	VMV-560ARETA3	
		-	-	-	VMV-504ARETA3	VMV-560ARETA3	VMV-560ARETA3	VMV-560ARETA3	
		-	-	-	-	-	-	-	
Capacity	Capacity range (HP)	48	50	52	54	56	58	60	
	Cooling (kW)	136.0	141.5	147.0	151.2	156.8	162.4	168.0	
	Heating (kW)	136.0	141.5	147.0	151.2	156.8	162.4	168.0	
	Heating - Max. (kW)	146.0	155.5	165.0	169.5	174.5	179.5	184.5	
Electrical parameters	Power supply (Ph/V/Hz)	3/380-415/50/60							
	Cooling	Rated power input (kW)	45.34	49.89	54.44	46.81	47.82	48.84	49.85
		Max power input (kW)	58.20	66.90	75.60	64.20	67.90	71.60	75.30
		Rated current (A)	76.54	84.23	91.91	79.03	80.74	82.45	84.16
		Max current (A)	98.25	111.04	123.82	108.38	114.63	120.88	127.12
	Heating	Rated power input (kW)	38.9	45.7	52.5	39.6	41.0	42.5	44.0
		Max power input (kW)	53.00	56.90	60.80	53.10	58.10	63.10	68.10
		Rated current (A)	65.6	78.5	91.4	66.8	69.3	71.8	74.2
		Max current (A)	89.48	96.06	102.64	89.64	98.08	106.53	114.97
	SEER	5.83	4.90	4.90	6.78	6.75	6.75	6.75	
	SCOP	4.17	3.5	3.5	4.15	4.15	4.15	4.2	
	ηs,c (%)	230	193	193	268	267	267	267	
	ηs,c (%)	164	137	137	163	163	163	165	
Performance	Air flow (m³/h)	36000	37000	38000	51000	51000	51000	51000	
	Sound pressure level (dB(A))	65	65	65	66	66	66	66	

3/380~415/50/60



Total pipe length 1000 m, height drop 110 m



Auto addressing indoor units



Space saving



Better cooling capacity



VMV-252ARETA3
VMV-280ARETA3
VMV-335ARETA3
VMV-400ARETA3
VMV-450ARETA3



VMV-504ARETA3
VMV-560ARETA3
VMV-615ARETA3
VMV-680ARETA3
VMV-735ARETA3

Model		VMV-1360ARETA3	VMV-1415ARETA3	VMV-1470ARETA3	VMV-1512ARETA3	VMV-1568ARETA3	VMV-1624ARETA3	VMV-1680ARETA3
Installation	External dimensions - W/D/H (mm)	1410/1690/750 + 1410/1690/750			1410/1690/750 + 1410/1690/750 + 1410/1690/750			
	Shipping dimensions - W/D/H (mm)	1515/1858/850 + 1515/1858/850			1515/1858/850 + 1515/1858/850 + 1515/1858/850			
	Net/Shipping weight (kg)	370/400 + 370/400			287/317 + 287/317 +287/317	287/317 + 287/317 + 370/400	287/317 + 370/400 + 370/400	370/400 + 370/400 + 370/400
	Compressor type	DC INV. SCROLL						
	Compressor quantity	4INV	4INV	4INV	3INV	4INV	5INV	6INV
	Refrigerant type	R410A						
	Refrigerant charge (kg)	20	20	20	30	30	30	30
	Refrigerant liquid pipe (mm)	19.05	19.05	19.05	19.05	19.05	19.05	19.05
	Refrigerant gas pipe (mm)	38.1	38.1	38.1	38.1	38.1	41.3	41.3
	Max.total pipe length (m)	1000						
	Max. pipe length (Equivalent/Actual)	260/220						
	Max drop between I.U. & O.U. (O.U. down/up) *1 (m)	110/90						
	Standard drop between I.U. & O.U. (O.U. up/down) *2 (m)	50/40						
	Max drop between I.U. *3 (m)	30						
	Standard drop between I.U. *4 (m)	18						
External static pressure (Pa)	110							
Connection ratio	Connectable indoor unit ratio (%)	50-130						
	Maximum number of indoor units	64	64	64	64	64	64	64
Working temp.	Cooling (°C)	-5-50						
	Heating (°C)	-23-21						

Max drop between I.U. & O.U *1 - If the height difference between the outdoor and the indoor units is from 50 to 110 m, contact your local distributor / dealer for individual design and production.

Standard drop between I.U. & O.U *2 - Standard design and production in the factory.

Max drop between I.U. *3 - If the height difference between the indoor units is from 18 to 30 m, contact your local distributor/dealer for individual design and production.

Standard drop between I.U. *4 - Standard design and production in the factory.

* All the specifications are tested under nominal condition(in cooling, indoor temp. is 27 °C DB / 19 °C WB; Outdoor temp. 35 °C DB / 24 WB; in heating, indoor temp. is 20 °C DB, in heating, outdoor temp. is 7 °C DB / 6 °C WB).

Model		VMV-1735ARETA3	VMV-1790ARETA3	VMV-1845ARETA3	VMV-1910ARETA3	VMV-1975ARETA3	VMV-2040ARETA3	VMV-2095ARETA3	
	Combination model	VMV-615ARETA3	VMV-615ARETA3	VMV-615ARETA3	VMV-615ARETA3	VMV-615ARETA3	VMV-680ARETA3	VMV-735ARETA3	
		VMV-560ARETA3	VMV-615ARETA3	VMV-615ARETA3	VMV-615ARETA3	VMV-615ARETA3	VMV-680ARETA3	VMV-680ARETA3	VMV-680ARETA3
		VMV-560ARETA3	VMV-560ARETA3	VMV-615ARETA3	VMV-680ARETA3	VMV-680ARETA3	VMV-680ARETA3	VMV-680ARETA3	VMV-680ARETA3
		-	-	-	-	-	-	-	-
Capacity	Capacity range (HP)	62	64	66	68	70	72	74	
	Cooling (kW)	173.5	179.0	184.5	191.0	197.5	204.0	209.5	
	Heating (kW)	173.5	179.0	184.5	191.0	197.5	204.0	209.5	
	Heating - Max. (kW)	192.0	199.5	207.0	211.0	215.0	219.0	228.5	
Electrical parameters	Power supply (Ph/V/Hz)	3 / 380 ~ 415 / 50 / 60							
	Cooling	Rated power input (kW)	53.39	56.94	60.48	62.99	65.50	68.01	72.56
		Max power input (kW)	78.70	82.10	85.50	86.10	86.70	87.30	96.00
		Rated current (A)	90.17	96.17	102.18	106.39	110.60	114.82	122.50
		Max current (A)	132.86	138.60	144.34	145.35	146.37	147.38	160.16
	Heating	Rated power input (kW)	48.0	51.9	55.9	56.7	57.5	58.3	65.1
		Max power input (kW)	70.90	73.70	76.50	77.50	78.50	79.50	83.40
		Rated current (A)	81.0	87.7	94.5	95.8	97.1	98.4	111.3
		Max current (A)	119.69	124.42	129.15	130.84	132.52	134.21	140.80
	SEER	6.54	6.54	6.54	5.83	5.83	5.83	4.90	
	SCOP	4.2	4.2	4.21	4.17	4.17	4.17	3.5	
	ηs,c (%)	259	259	259	230	230	230	193	
ηs,c (%)	165	165	165	164	164	164	137		
Performance	Air flow (m³/h)	52000	53000	54000	54000	54000	54000	55000	
	Sound pressure level (dB(A))	66	66	66	66	66	67	67	

3/380~415/50/60



Total pipe length 1000 m, height drop 110 m



Auto addressing indoor units



Space saving



Better cooling capacity



VMV-252ARETA3
VMV-280ARETA3
VMV-335ARETA3
VMV-400ARETA3
VMV-450ARETA3



VMV-504ARETA3
VMV-560ARETA3
VMV-615ARETA3
VMV-680ARETA3
VMV-735ARETA3

Model		VMV-1735ARETA3	VMV-1790ARETA3	VMV-1845ARETA3	VMV-1910ARETA3	VMV-1975ARETA3	VMV-2040ARETA3	VMV-2095ARETA3
Installation	External dimensions - W/D/H (mm)	1410/1690/750 + 1410/1690/750 + 1410/1690/750						
	Shipping dimensions - W/D/H (mm)	1515/1858/850 + 1515/1858/850 + 1515/1858/850						
	Net/Shipping weight (kg)	370/400 + 370/400 + 370/400						
	Compressor type	DC INV. SCROLL						
	Compressor quantity	6INV	6INV	6INV	6INV	6INV	6INV	6INV
	Refrigerant type	R410A						
	Refrigerant charge (kg)	30	30	30	30	30	30	30
	Refrigerant liquid pipe (mm)	19.05	19.05	19.05	22.2	22.2	22.2	22.2
	Refrigerant gas pipe (mm)	41.3	41.3	41.3	44.5	44.5	44.5	44.5
	Max.total pipe lenth (m)	1000						
	Max. pipe length (Equivalent/Actual)	260/220						
	Max drop between I.U. & O.U. (O.U. down/up) *1 (m)	110/90						
	Standard drop between I.U. & O.U. (O.U. up/down) *2 (m)	50/40						
	Max drop between I.U. *3 (m)	30						
	Standard drop between I.U. *4 (m)	18						
External static pressure (Pa)	110							
Connection ratio	Connectable indoor unit ratio (%)	50-130						
	Maximum number of indoor units	64	64	64	64	64	64	64
Working temp.	Cooling (°C)	-5-50						
	Heating (°C)	-23-21						

Max drop between I.U. & O.U *1 - If the height difference between the outdoor and the indoor units is from 50 to 110 m, contact your local distributor / dealer for individual design and production.

Standard drop between I.U. & O.U *2 - Standard design and production in the factory.

Max drop between I.U. *3 - If the height difference between the indoor units is from 18 to 30 m, contact your local distributor/dealer for individual design and production.

Standard drop between I.U. *4 - Standard design and production in the factory.

* All the specifications are tested under nominal condition (in cooling, indoor temp. is 27 °C DB / 19 °C WB; Outdoor temp. 35 °C DB / 24 WB; in heating, indoor temp. is 20 °C DB, in heating, outdoor temp. is 7 °C DB / 6 °C WB).

Model		VMV-2150ARETA3	VMV-2205ARETA3	VMV-2240ARETA3	VMV-2295ARETA3	VMV-2350ARETA3	VMV-2405ARETA3	VMV-2460ARETA3	VMV-2525ARETA3	
Combination model		VMV-735ARETA3	VMV-735ARETA3	VMV-560ARETA3	VMV-560ARETA3	VMV-560ARETA3	VMV-560ARETA3	VMV-615ARETA3	VMV-680ARETA3	
		VMV-735ARETA3	VMV-735ARETA3	VMV-560ARETA3	VMV-560ARETA3	VMV-560ARETA3	VMV-615ARETA3	VMV-615ARETA3	VMV-615ARETA3	
		VMV-680ARETA3	VMV-735ARETA3	VMV-560ARETA3	VMV-560ARETA3	VMV-615ARETA3	VMV-615ARETA3	VMV-615ARETA3	VMV-615ARETA3	
		-	-	VMV-560ARETA3	VMV-615ARETA3	VMV-615ARETA3	VMV-615ARETA3	VMV-615ARETA3	VMV-615ARETA3	
Capacity	Capacity range (HP)	76	78	80	82	84	86	88	90	
	Cooling (kW)	215.0	220.5	224.0	229.5	235.0	240.5	246.0	252.5	
	Heating (kW)	215.0	220.5	224.0	229.5	235.0	240.5	246.0	252.5	
	Heating - Max. (kW)	238.0	247.5	246.0	253.5	261.0	268.5	276.0	280.0	
Electrical parameters	Power supply (Ph/V/Hz)	3/380 ~ 415/50/60								
	Cooling	Rated power input (kW)	77.11	81.67	66.47	70.01	73.55	77.10	80.64	83.15
		Max power input (kW)	104.70	113.40	100.40	103.80	107.20	110.60	114.00	114.60
		Rated current (A)	130.19	137.87	112.21	118.22	124.23	130.23	136.24	140.45
		Max current (A)	172.95	185.73	169.50	175.24	180.98	186.72	192.46	193.47
	Heating	Rated power input (kW)	71.9	78.8	58.6	62.6	66.6	70.6	74.6	75.3
		Max power input (kW)	87.30	91.20	90.80	93.60	96.40	99.20	102.00	103.00
		Rated current (A)	124.2	137.0	99.0	105.7	112.5	119.2	126.0	127.3
		Max current (A)	147.38	153.96	153.29	158.02	162.74	167.47	172.20	173.89
	SEER	4.90	4.90	6.75	6.54	6.54	6.54	6.54	5.83	
	SCOP	3.5	3.5	4.2	4.2	4.2	4.2	4.21	4.17	
	ηs,c (%)	193	193	267	259	259	259	259	230	
ηs,c (%)	137	137	165	165	165	165	165	164		
Performance	Air flow (m³ / h)	56000	57000	68000	69000	70000	71000	72000	72000	
	Sound pressure level (dB(A))	67	67	67	67	67	67	67	67	

3/380~415/50/60



Total pipe length 1000 m, height drop 110 m



Auto addressing indoor units



Space saving



Better cooling capacity



VMV-252ARETA3
VMV-280ARETA3
VMV-335ARETA3
VMV-400ARETA3
VMV-450ARETA3



VMV-504ARETA3
VMV-560ARETA3
VMV-615ARETA3
VMV-680ARETA3
VMV-735ARETA3

Model		VMV-2150ARETA3	VMV-2205ARETA3	VMV-2240ARETA3	VMV-2295ARETA3	VMV-2350ARETA3	VMV-2405ARETA3	VMV-2460ARETA3	VMV-2525ARETA3	
Installation	External dimensions - W/D/H (mm)	1410/1690/750 + 1410/1690/750 + 1410/1690/750			1410/1690/750 + 1410/1690/750 + 1410/1690/750 + 1410/1690/750					
	Shipping dimensions - W/D/H (mm)	1515/1858/850 + 1515/1858/850 + 1515/1858/850			1515/1858/850 + 1515/1858/850 + 1515/1858/850 + 1515/1858/850					
	Net/Shipping weight (kg)	370/400 + 370/400 + 370/400			370/400 + 370/400 + 370/400 + 370/400					
	Compressor type	DC INV. SCROLL								
	Compressor quantity	6INV	6INV	8INV	8INV	8INV	8INV	8INV	8INV	8INV
	Refrigerant type	R410A								
	Refrigerant charge (kg)	30.0	30.0	40.0	40.0	40.0	40.0	40.0	40.0	40.0
	Refrigerant liquid pipe (mm)	22.2	22.2	22.2	22.2	22.2	22.2	25.4	25.4	25.4
	Refrigerant gas pipe (mm)	44.5	44.5	44.5	44.5	44.5	44.5	50.8	50.8	50.8
	Max.total pipe lenth (m)	1000								
	Max. pipe length (Equivalent/Actual)	260/220								
	Max drop between I.U. & O.U. (O.U. down/up) *1 (m)	110/90								
	Standard drop between I.U. & O.U. (O.U. up/down) *2 (m)	50/40								
	Max drop between I.U. *3 (m)	30								
	Standard drop between I.U. *4 (m)	18								
External static pressure (Pa)	110									
Connection ratio	Connectable indoor unit ratio (%)	50-130								
	Maximum number of indoor units	64	64	64	64	64	64	64	64	64
Working temp.	Cooling (°C)	-5-50								
	Heating (°C)	-23-21								

Max drop between I.U. & O.U *1 - If the height difference between the outdoor and the indoor units is from 50 to 110 m, contact your local distributor / dealer for individual design and production.

Standard drop between I.U. & O.U *2 - Standard design and production in the factory.

Max drop between I.U. *3 - If the height difference between the indoor units is from 18 to 30 m, contact your local distributor/dealer for individual design and production.

Standard drop between I.U. *4 - Standard design and production in the factory.

* All the specifications are tested under nominal condition(in cooling, indoor temp. is 27 °C DB / 19 °C WB; Outdoor temp. 35 °C DB / 24 WB; in heating, indoor temp. is 20 °C DB, in heating, outdoor temp. is 7 °C DB / 6 °C WB).

Model		VMV-2590ARETA3	AV94IMVEVA	VMV-2655ARETA3	VMV-2720ARETA3	VMV-2775ARETA3	VMV-2830ARETA3	VMV-2885ARETA3	
Combination model		VMV-680ARETA3	VMV-680ARETA3	VMV-680ARETA3	VMV-735ARETA3	VMV-735ARETA3	VMV-735ARETA3	VMV-735ARETA3	
		VMV-680ARETA3	VMV-680ARETA3	VMV-680ARETA3	VMV-680ARETA3	VMV-735ARETA3	VMV-735ARETA3	VMV-735ARETA3	
		VMV-615ARETA3	VMV-680ARETA3	VMV-680ARETA3	VMV-680ARETA3	VMV-680ARETA3	VMV-735ARETA3	VMV-735ARETA3	
		VMV-615ARETA3	VMV-615ARETA3	VMV-680ARETA3	VMV-680ARETA3	VMV-680ARETA3	VMV-680ARETA3	VMV-735ARETA3	
Capacity	Capacity range (HP)	92	94	96	98	100	102	104	
	Cooling (kW)	259.0	265.5	272.0	277.5	283.0	288.5	294.0	
	Heating (kW)	259.0	265.5	272.0	277.5	283.0	288.5	294.0	
	Heating - Max. (kW)	284.0	288.0	292.0	301.5	311.0	320.5	330.0	
Electrical parameters	Power supply (Ph/V/Hz)	3/380 ~ 415/50/60							
	Cooling	Rated power input (kW)	85.66	88.17	90.68	95.23	99.78	104.34	108.89
		Max power input (kW)	115.20	115.80	116.40	125.10	133.80	142.50	151.20
		Rated current (A)	144.66	148.88	153.09	160.77	168.46	176.14	183.83
		Max current (A)	194.48	195.49	196.51	209.29	222.07	234.86	247.64
	Heating	Rated power input (kW)	76.1	76.9	77.7	84.5	91.4	98.2	105.0
		Max power input (kW)	104.00	105.00	106.00	109.90	113.80	117.70	121.60
		Rated current (A)	128.6	129.9	131.2	144.1	157.0	169.8	182.7
		Max current (A)	175.57	177.26	178.95	185.53	192.12	198.70	205.29
	SEER	5.83	5.83	5.83	4.90	4.90	4.90	4.90	
	SCOP	4.17	4.17	4.17	3.5	3.5	3.5	3.5	
	ηs,c (%)	230	230	230	193	193	193	193	
	ηs,c (%)	164	164	164	137	137	137	137	
	Performance	Air flow (m³/h)	72000	72000	72000	73000	74000	75000	76000
Sound pressure level (dB(A))		68	68	67	67	68	68	68	

3/380~415/50/60



Total pipe length 1000 m, height drop 110 m



Auto addressing indoor units



Space saving



Better cooling capacity



VMV-252ARETA3
VMV-280ARETA3
VMV-335ARETA3
VMV-400ARETA3
VMV-450ARETA3



VMV-504ARETA3
VMV-560ARETA3
VMV-615ARETA3
VMV-680ARETA3
VMV-735ARETA3

Model		VMV-2590ARETA3	AV94IMVEVA	VMV-2655ARETA3	VMV-2720ARETA3	VMV-2775ARETA3	VMV-2830ARETA3	VMV-2885ARETA3
Installation	External dimensions - W/D/H (mm)	1410/1690/750 + 1410/1690/750 + 1410/1690/750 + 1410/1690/750						
	Shipping dimensions - W/D/H (mm)	1515/1858/850 + 1515/1858/850 + 1515/1858/850 + 1515/1858/850						
	Net / Shipping weight (kg)	370/400 + 370/400 + 370/400 + 370/400						
	Compressor type	DC INV. SCROLL						
	Compressor quantity	8INV	8INV	8INV	8INV	8INV	8INV	8INV
	Refrigerant type	R410A						
	Refrigerant charge (kg)	40	40	40	40	40	40	40
	Refrigerant liquid pipe (mm)	25.4	25.4	25.4	25.4	25.4	25.4	25.4
	Refrigerant gas pipe (mm)	50.8	50.8	50.8	54.1	54.1	54.1	54.1
	Max.total pipe length (m)	1000						
	Max. pipe length (Equivalent / Actual)	260/220						
	Max drop between I.U. & O.U. (O.U. down / up) *1 (m)	110/90						
	Standard drop between I.U. & O.U. (O.U. up / down) *2 (m)	50/40						
	Max drop between I.U. *3 (m)	30						
Standard drop between I.U. *4 (m)	18							
External static pressure (Pa)	110							
Connection ratio	Connectable indoor unit ratio (%)	50-130						
	Maximum number of indoor units	64	64	64	64	64	64	64
Working temp.	Cooling (°C)	-5-50						
	Heating (°C)	-23-21						

Max drop between I.U. & O.U *1 - If the height difference between the outdoor and the indoor units is from 50 to 110 m, contact your local distributor / dealer for individual design and production.

Standard drop between I.U. & O.U *2 - Standard design and production in the factory.

Max drop between I.U. *3 - If the height difference between the indoor units is from 18 to 30 m, contact your local distributor/dealer for individual design and production.

Standard drop between I.U. *4 - Standard design and production in the factory.

* All the specifications are tested under nominal condition (in cooling, indoor temp. is 27 °C DB / 19 °C WB; Outdoor temp. 35 °C DB / 24 WB; in heating, indoor temp. is 20 °C DB, in heating, outdoor temp. is 7 °C DB / 6 °C WB).

VIVAX VMV5H

DC INVERTER



High
efficiency



Super
comfort



Easy
installation

High Efficiency

EVI compressor and two-stage subcooling

VMV 5H units are equipped with a refrigerant sub-cooler and an enhanced vapor injection compressor. It is increasing the system performance and capacity in the wide range of ambient conditions, increasing the compressor efficiency, and reducing the operation costs.



EVI compressor

Normal compressor

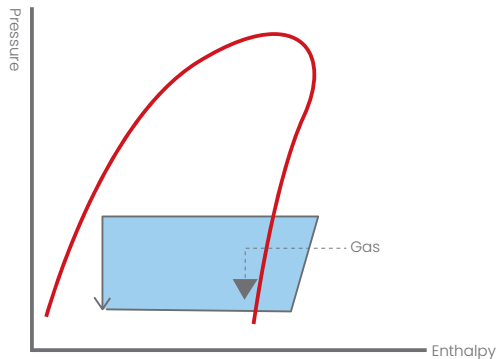
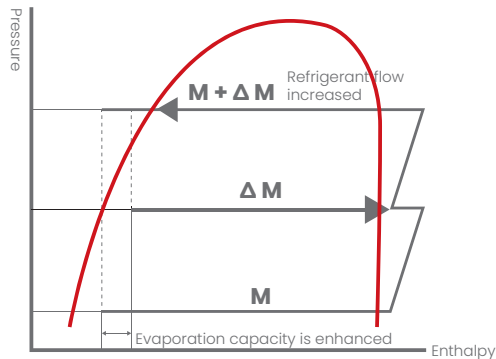

DC inverter stepless fan motor

The outdoor fan motor has stepless inverter regulation technology and is able to operate in the 0-91 Hz frequency range which increases efficiency.



Superconducting refrigerant cooling PCB technology

Adopt innovative super heat conduction cooling PCB technology, heat transfer media conduct heat 100 times better than copper. Does not occupy the refrigerant amount of the system, no additional refrigerant loss. At the same time, this cooling mode will not affect the rotation of the electric control box, easy maintain.

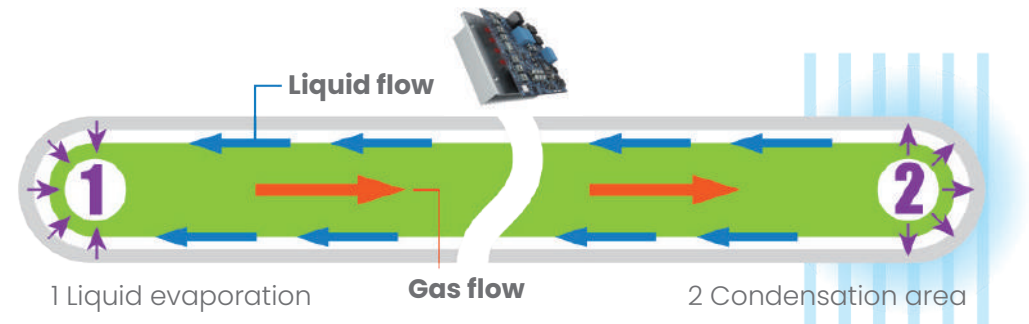

High comfort

Continuous heating technology

The VMV 5H units have intelligent defrost technology. During the light and medium defrost demand, defrosting is achieved by a hot-gas bypass ensuring the continuous heating and maximum comfort during defrosting of outdoor heat exchanger.



Precise temperature control

The VMV 5 units are equipped with double pressure sensors and double electronic expansion valves which enable the automatic refrigerant volume adjustment. With this technology indoor temperature could be controlled by 0,5 °C steps improving the comfort.

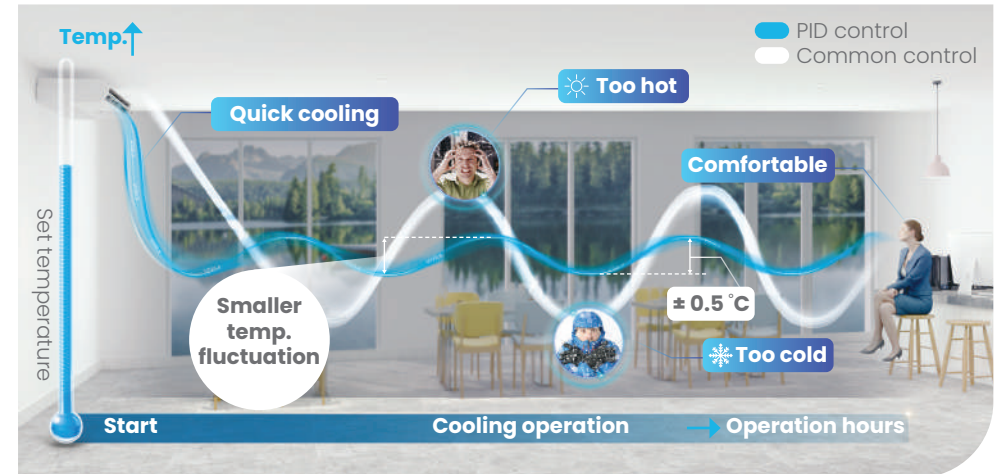

Wide operation temperature range

Special design of the VMV 5H series enables the heating operation at outdoor temperatures down to -27 °C, and coling operation at outdoor temperatures up to 52 °C. Cooling operation outdoor temperature range: -5 °C - 52 °C. Heating operation outdoor temperature range: -27 °C - 21 °C.



Easy installation

Auto addressing indoor units

The outdoor unit can automatically address the indoor units through the module on the PCB. It is more convenient and time saving as there is no need to manually set the addresses on each indoor units separately.

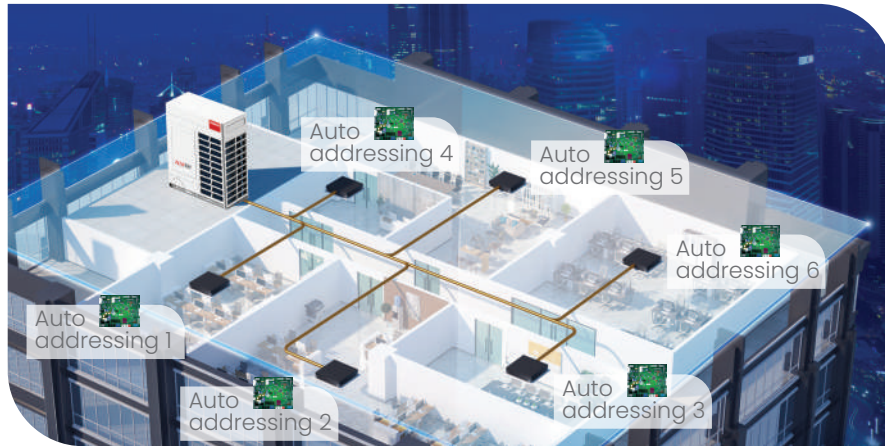

Easy access for maintenance and repair

Rotating design of the electronic control box allows easy access to all internal system components, and saves time during maintenance.



Four-way refrigerant piping connection

Refrigerant pipes can be connected from four different directions which makes the piping installation simpler while saving time and material.



Flexible long piping design

- 1000 m maximum total piping length
 - 220 m maximum actual piping length
 - 110 m / 90 m maximum height difference between ODU and IDU (ODU higher / IDU higher)
 - 30 m maximum height difference between IDU and IDU
- * for the total piping length between 300 m and 1000 m, and height difference greater than 50m please contact your supplier



Model		VMV-H252 ARETA3	VMV-H280 ARETA3	VMV-H335 ARETA3	VMV-H400 ARETA3	VMV-H450 ARETA3	VMV-H504 ARETA3	VMV-H560 ARETA3	VMV-H615 ARETA3	VMV-H680 ARETA3	VMV-H735 ARETA3	
	Combination model	-	-	-	-	-	-	-	-	-	-	
		-	-	-	-	-	-	-	-	-	-	
		-	-	-	-	-	-	-	-	-	-	
		-	-	-	-	-	-	-	-	-	-	
Capacity	Capacity range (HP)	8	10	12	14	16	18	20	22	24	26	
	Cooling (kW)	25,2	28,0	33,5	40,0	45,0	50,4	56,0	61,5	68,0	73,5	
	Heating (kW)	25,2	28,0	33,5	40,0	45,0	50,4	56,0	61,5	68,0	73,5	
	Heating - Max. (kW)	27,00	31,50	37,50	45,00	50,00	56,50	61,50	69,00	73,00	82,50	
Electrical parameters	Power supply (Ph/V/Hz)	3/380-415/50/60										
	Cooling	Rated power input (kW)	6.24	7.37	10.15	11.94	13.24	15.60	16.62	20.16	22.67	27.22
		Rated current (A)	14.30	15.10	16.32	17.58	20.69	25.90	28.91	31.82	32.81	37.80
		Max power input (kW)	10.53	12.44	17.14	20.16	22.34	26.34	28.05	34.03	38.27	45.96
		Max current (A)	23.81	25.14	27.17	29.27	34.50	40.30	46.30	51.91	54.12	61.91
		SEER	5.25	5.96	8.59	10.00	10.47	13.19	14.66	18.64	19.43	22.97
		η _{s,c} (%)	11.69	12.19	12.69	16.10	19.56	21.93	24.70	25.69	30.40	32.45
	Heating	Rated power input (kW)	8.86	10.06	14.50	16.88	17.67	22.27	24.75	31.46	32.80	38.78
		Rated current (A)	19.47	20.30	21.13	26.81	32.57	36.51	41.13	42.78	50.62	54.03
		Max power input (kW)	7.25	7.09	6.69	6.60	6.36	6.78	6.75	6.54	5.83	5.15
		Max current (A)	4.41	4.31	4.31	4.12	4.05	4.15	4.20	4.21	4.17	3.50
		SCOP	287	281	265	261	251	268	267	259	230	203
		η _{s,c} (%)	173	169	169	162	159	163	165	165	164	137
	Performance	Air flow (m ³ /h)	11000	11000	12000	13500	13500	17000	17000	18000	18000	19000
Sound pressure level (dB(A))		56.0	56.0	59.0	59.0	60.0	61.0	61.0	61.0	62.0	62.0	

3/380~415/50/60



Total pipe length 1000 m, height drop 110 m



EVI compressors



Single module 26 HP, maximum combination 104 HP



Intelligent defrosting technology



VMV-H252ARETA3
VMV-H280ARETA3
VMV-H335ARETA3
VMV-H400ARETA3
VMV-H450ARETA3



VMV-H504ARETA3
VMV-H560ARETA3
VMV-H615ARETA3
VMV-H680ARETA3
VMV-H735ARETA3

Model		VMV-H252 ARETA3	VMV-H280 ARETA3	VMV-H335 ARETA3	VMV-H400 ARETA3	VMV-H450 ARETA3	VMV-H504 ARETA3	VMV-H560 ARETA3	VMV-H615 ARETA3	VMV-H680 ARETA3	VMV-H735 ARETA3	
Installation	External dimensions - W/D/H (mm)	980/750/1690					1410/750/1690					
	Shipping dimensions - W/D/H (mm)	1070/850/1858					1515/850/1858					
	Net/Shipping weight (kg)	255/280					385/410					
	Compressor type	DC INV. SCROLL										
	Compressor quantity	1INV	1INV	1INV	1INV	1INV	2INV	2INV	2INV	2INV	2INV	
	Refrigerant type	R410A										
	Refrigerant charge (kg)	10	10	10	10	10	10	10	10	10	10	
	Refrigerant liquid pipe (mm)	9.52	9.52	12.70	12.70	12.70	15.88	15.88	15.88	15.88	15.88	
	Refrigerant gas pipe (mm)	19.05	22.22	25.40	25.40	28.58	28.58	28.58	28.58	28.58	28.58	
	Max.total pipe lenth (m)	1000										
	Max. pipe length (Equivalent/Actual)	260/220										
	Max drop between I.U. & O.U. (O.U. down/up) *1 (m)	110/90										
	Standard drop between I.U. & O.U. (O.U. up/down) *2 (m)	50/40										
	Max drop between I.U. *3 (m)	30										
Standard drop between I.U. *4 (m)	18											
External static pressure (Pa)	110											
Connection ratio	Connectable indoor unit ratio (%)	50-130										
	Maximum number of indoor units	13	16	20	24	27	30	33	36	40	43	
Working temp.	Cooling (°C)	-5~52										
	Heating (°C)	-27~21										

Max drop between I.U. & O.U *1 - If the height difference between the outdoor and the indoor units is from 50 to 110 m, contact your local distributor / dealer for individual design and production.

Standard drop between I.U. & O.U *2 - Standard design and production in the factory.

Max drop between I.U. *3 - If the height difference between the indoor units is from 18 to 30 m, contact your local distributor/dealer for individual design and production.

Standard drop between I.U. *4 - Standard design and production in the factory.

* All the specifications are tested under nominal condition(in cooling, indoor temp. is 27 °C DB / 19 °C WB; Outdoor temp. 35 °C DB / 24 WB; in heating, indoor temp. is 20 °C DB, in heating, outdoor temp. is 7 °C DB / 6 °C WB).

Model		VMV-H800ARETA3	VMV-H850ARETA3	VMV-H900ARETA3	VMV-H954ARETA3	VMV-H1008ARETA3	VMV-H1064ARETA3	
Combination model		VMV-H400ARETA3	VMV-H400ARETA3	VMV-H450ARETA3	VMV-H450ARETA3	VMV-H504ARETA3	VMV-H504ARETA3	
		VMV-H400ARETA3	VMV-H450ARETA3	VMV-H450ARETA3	VMV-H504ARETA3	VMV-H504ARETA3	VMV-H560ARETA3	
		-	-	-	-	-	-	
		-	-	-	-	-	-	
Capacity	Capacity range (HP)	28	30	32	34	36	38	
	Cooling (kW)	80.0	85.0	90.0	95.4	100.8	106.4	
	Heating (kW)	80.00	85.00	90.00	95.40	100.80	106.40	
	Heating - Max. (kW)	90.0	95.0	100.0	106.5	113.0	118.0	
Electrical parameters	Power supply (Ph/V/Hz)	3/380-415/50/60						
	Cooling	Rated power input (kW)	23.88	25.18	26.47	28.84	31.20	32.22
		Rated current (A)	40.32	42.50	44.69	48.68	52.67	54.39
		Max power input (kW)	35.16	38.27	41.38	46.59	51.80	54.81
		Max current (A)	58.54	63.77	69.00	74.80	86.60	86.60
		SEER	6.60	6.36	6.36	6.36	6.78	6.75
		$\eta_{s,c}$ (%)	261	251	251	251	268	267
	Heating	Rated power input (kW)	20.00	21.25	22.50	24.44	26.39	27.85
		Rated current (A)	33.76	35.87	37.98	41.27	44.55	47.02
		Max power input (kW)	32.20	35.66	39.12	41.49	43.86	46.63
		Max current (A)	53.61	59.38	65.14	69.08	73.03	77.64
		SCOP	4.12	4.05	4.05	4.05	4.15	4.15
		$\eta_{s,c}$ (%)	162	159	159	159	163	163
	Performance	Air flow (m ³ /h)	27000	27000	27000	30500	34000	34000
Sound pressure level (dB(A))		62	62.5	63	63.5	64	64	

3/380~415/50/60



Total pipe length 1000 m, height drop 110 m



EVI compressors



Single module 26 HP, maximum combination 104 HP



Intelligent defrosting technology



VMV-H252ARETA3
VMV-H280ARETA3
VMV-H335ARETA3
VMV-H400ARETA3
VMV-H450ARETA3



VMV-H504ARETA3
VMV-H560ARETA3
VMV-H615ARETA3
VMV-H680ARETA3
VMV-H735ARETA3

Model		VMV-H800ARETA3	VMV-H850ARETA3	VMV-H900ARETA3	VMV-H954ARETA3	VMV-H1008ARETA3	VMV-H1064ARETA3
Installation	External dimensions - W/D/H (mm)	980/750/1690 + 980/750/1690			980/750/1690 + 1410/750/1690	1410/750 /1690 + 1410/750/1690	
	Shipping dimensions - W/D/H (mm)	1070/850/1858 + 1070/850/1858			1070/850/1858 + 1515/850/1858	1515/850/1858 + 1515/850/1858	
	Net/Shipping weight (kg)	255/280 + 255/280	256/280 + 255/280	257/280 + 255/280	255/280 + 385/410	385/410 + 385/410	385/410 + 385/410
	Compressor type	DC INV. SCROLL					
	Compressor quantity	2INV	2INV	2INV	3INV	4INV	4INV
	Refrigerant type	R410A					
	Refrigerant charge (kg)	20.0	20.0	20.0	20.0	20.0	20.0
	Refrigerant liquid pipe (mm)	15.88	19.05	19.05	19.05	19.05	19.05
	Refrigerant gas pipe (mm)	28.58	31.8	31.8	31.8	38.1	38.1
	Max.total pipe lenth (m)	1000					
	Max. pipe length (Equivalent/Actual)	260/220					
	Max drop between I.U. & O.U. (O.U. down/up) *1 (m)	110/90					
	Standard drop between I.U. & O.U. (O.U. up/down) *2 (m)	50/40					
	Max drop between I.U. *3 (m)	30					
Standard drop between I.U. *4 (m)	18						
External static pressure (Pa)	110						
Connection ratio	Connectable indoor unit ratio (%)	50-130					
	Maximum number of indoor units	47	50	53	56	59	63
Working temp.	Cooling (°C)	-5-52					
	Heating (°C)	-27-21					

Max drop between I.U. & O.U *1 - If the height difference between the outdoor and the indoor units is from 50 to 110 m, contact your local distributor / dealer for individual design and production.

Standard drop between I.U. & O.U *2 - Standard design and production in the factory.

Max drop between I.U. *3 - If the height difference between the indoor units is from 18 to 30 m, contact your local distributor/dealer for individual design and production.

Standard drop between I.U. *4 - Standard design and production in the factory.

* All the specifications are tested under nominal condition(in cooling, indoor temp. is 27 °C DB / 19 °C WB; Outdoor temp. 35 °C DB / 24 WB; in heating, indoor temp. is 20 °C DB, in heating, outdoor temp. is 7 °C DB / 6 °C WB).

Model		VMV-H1120 ARETA3	VMV-H1175 ARETA3	VMV-H1230 ARETA3	VMV-H1295 ARETA3	VMV-H1360 ARETA3	VMV-H1415 ARETA3	VMV-H1470 ARETA3	VMV-H1512 ARETA3	VMV-H1568 ARETA3	
Combination model		VMV-H560ARETA3	VMV-H560ARETA3	VMV-H615ARETA3	VMV-H615ARETA3	VMV-H680ARETA3	VMV-H680ARETA3	VMV-H735ARETA3	VMV-H504ARETA3	VMV-H504ARETA3	
		VMV-H560ARETA3	VMV-H615ARETA3	VMV-H615ARETA3	VMV-H680ARETA3	VMV-H680ARETA3	VMV-H735ARETA3	VMV-H735ARETA3	VMV-H504ARETA3	VMV-H504ARETA3	
		-	-	-	-	-	-	-	VMV-H504ARETA3	VMV-H560ARETA3	
		-	-	-	-	-	-	-	-	-	
Capacity	Capacity range (HP)	40	42	44	46	48	50	52	54	56	
	Cooling (kW)	112,0	117,5	123,0	129,5	136,0	141,5	147,0	151,2	156,8	
	Heating (kW)	112,00	117,50	123,00	129,50	136,00	141,50	147,00	151,20	156,80	
	Heating - Max. (kW)	123,0	130,5	138,0	142,0	146,0	155,5	165,0	169,5	174,5	
Electrical parameters	Power supply (Ph / V / Hz)	3/380-415/50/60									
	Cooling	Rated power input (kW)	33.23	36.78	40.32	42.83	45.34	49.89	54.44	46.81	47.82
		Rated current (A)	57.82	60.73	63.64	64.63	65.62	70.61	75.60	77.70	80.71
		Max power input (kW)	56.11	62.09	68.07	72.31	76.54	84.23	91.91	79.03	80.74
		Max current (A)	92.60	98.21	103.82	106.03	108.24	116.03	123.82	120.90	126.90
		SEER	29.32	33.30	37.27	38.06	38.86	42.40	45.94	39.58	41.05
	$\eta_{s,c}$ (%)	49.40	50.39	51.38	56.09	60.80	62.85	64.90	65.79	68.56	
	Heating	Rated power input (kW)	49.5	56.2	62.9	64.3	65.6	71.6	77.6	66.8	69.3
		Rated current (A)	82.25	83.90	85.55	93.39	101.23	104.65	108.06	109.54	114.15
		Max power input (kW)	6.75	6.54	6.54	5.83	5.83	5.15	5.15	6.78	6.75
		Max current (A)	4.2	4.2	4.21	4.17	4.17	3.5	3.5	4.15	4.15
		SCOP	267	259	259	230	230	203	203	268	267
		$\eta_{s,c}$ (%)	165	165	165	164	164	137	137	163	163
	Performance	Air flow (m ³ / h)	34000	35000	36000	36000	36000	37000	38000	51000	51000
Sound pressure level (dB(A))		64.0	64.0	64.0	64.5	65.0	65.0	65.0	65.8	65.8	

3/380~415/50/60



Total pipe length 1000 m, height drop 110 m



EVI compressors



Single module 26 HP, maximum combination 104 HP



Intelligent defrosting technology



VMV-H252ARETA3
VMV-H280ARETA3
VMV-H335ARETA3
VMV-H400ARETA3
VMV-H450ARETA3



VMV-H504ARETA3
VMV-H560ARETA3
VMV-H615ARETA3
VMV-H680ARETA3
VMV-H735ARETA3

Model		VMV-H1120 ARETA3	VMV-H1175 ARETA3	VMV-H1230 ARETA3	VMV-H1295 ARETA3	VMV-H1360 ARETA3	VMV-H1415 ARETA3	VMV-H1470 ARETA3	VMV-H1512 ARETA3	VMV-H1568 ARETA3	
Installation	External dimensions - W/D/H (mm)	1410/750/1690 + 1410/750/1690								1410/750/1690 + 1410/750/1690 + 1410/750/1690	
	Shipping dimensions - W/D/H (mm)	1515/850/1858 + 1515/850/1858								1515/850/1858 + 1515/850/1858 + 1515/850/1858	
	Net/Shipping weight (kg)	385/410 + 385/410								385/410 + 385/410 + 385/410	
	Compressor type	DC INV. SCROLL									
	Compressor quantity	4INV	4INV	4INV	4INV	4INV	4INV	4INV	4INV	6INV	6INV
	Refrigerant type	R410A									
	Refrigerant charge (kg)	20.0	20.0	20.0	20.0	20.0	20.0	20.0	20.0	30.0	30.0
	Refrigerant liquid pipe (mm)	19.05	19.05	19.05	19.05	19.05	19.05	19.05	19.05	19.05	19.05
	Refrigerant gas pipe (mm)	38.1	38.1	38.1	38.1	38.1	38.1	38.1	38.1	38.1	38.1
	Max.total pipe lenth (m)	1000									
	Max. pipe length (Equivalent/Actual)	260/220									
	Max drop between I.U. & O.U. (O.U. down/up) *1 (m)	110/90									
	Standard drop between I.U. & O.U. (O.U. up/down) *2 (m)	50/40									
	Max drop between I.U. *3 (m)	30									
Standard drop between I.U. *4 (m)	18										
External static pressure (Pa)	110										
Connection ratio	Connectable indoor unit ratio (%)	50-130									
	Maximum number of indoor units	64	64	64	64	64	64	64	64	64	64
Working temp.	Cooling (°C)	-5-52									
	Heating (°C)	-27-21									

Max drop between I.U. & O.U *1 - If the height difference between the outdoor and the indoor units is from 50 to 110 m, contact your local distributor / dealer for individual design and production.

Standard drop between I.U. & O.U *2 - Standard design and production in the factory.

Max drop between I.U. *3 - If the height difference between the indoor units is from 18 to 30 m, contact your local distributor/dealer for individual design and production.

Standard drop between I.U. *4 - Standard design and production in the factory.

* All the specifications are tested under nominal condition (in cooling, indoor temp. is 27 °C DB / 19 °C WB; Outdoor temp. 35 °C DB / 24 WB; in heating, indoor temp. is 20 °C DB, in heating, outdoor temp. is 7 °C DB / 6 °C WB).

Model		VMV-H1624ARETA3	VMV-H1680ARETA3	VMV-H1735ARETA3	VMV-H1790ARETA3	VMV-H1845ARETA3	VMV-H1910ARETA3	VMV-H1975ARETA3	VMV-H2040ARETA3	
Combination model		VMV-H504ARETA3	VMV-H560ARETA3	VMV-H615ARETA3	VMV-H615ARETA3	VMV-H615ARETA3	VMV-H615ARETA3	VMV-H615ARETA3	VMV-H680ARETA3	
		VMV-H560ARETA3	VMV-H560ARETA3	VMV-H560ARETA3	VMV-H615ARETA3	VMV-H615ARETA3	VMV-H615ARETA3	VMV-H680ARETA3	VMV-H680ARETA3	
		VMV-H560ARETA3	VMV-H560ARETA3	VMV-H560ARETA3	VMV-H560ARETA3	VMV-H615ARETA3	VMV-H680ARETA3	VMV-H680ARETA3	VMV-H680ARETA3	
		-	-	-	-	-	-	-	-	
Capacity	Capacity range (HP)	58	60	62	64	66	68	70	72	
	Cooling (kW)	162.4	168.0	173.5	179.0	184.5	191.0	197.5	204.0	
	Heating (kW)	162.40	168.00	173.50	179.00	184.50	191.00	197.50	204.00	
	Heating - Max. (kW)	179.5	184.5	192.0	199.5	207.0	211.0	215.0	219.0	
Electrical parameters	Power supply (Ph/V/Hz)	3/380-415/50/60								
	Cooling	Rated power input (kW)	48.84	49.85	53.39	56.94	60.48	62.99	65.50	68.01
		Rated current (A)	83.72	86.73	89.64	92.55	95.46	96.45	97.44	98.43
		Max power input (kW)	82.45	84.16	90.14	96.12	102.10	106.34	110.58	114.82
		Max current (A)	132.90	138.90	144.51	150.12	155.73	157.94	160.15	162.36
		SEER	42.51	43.98	47.96	51.93	55.91	56.70	57.49	58.29
		η _{s,c} (%)	71.33	74.10	75.09	76.08	77.08	81.78	86.49	91.20
	Heating	Rated power input (kW)	71.8	74.2	81.0	87.7	94.4	95.7	97.1	98.4
		Rated current (A)	118.76	123.38	125.03	126.68	128.33	136.17	144.01	151.85
		Max power input (kW)	6.75	6.75	6.54	6.54	6.54	5.83	5.83	5.83
		Max current (A)	4.15	4.2	4.2	4.2	4.21	4.17	4.17	4.17
		SCOP	267	267	259	259	259	230	230	230
η _{s,c} (%)		163	165	165	165	165	164	164	164	
Performance	Air flow (m³/h)	51000	51000	52000	53000	54000	54000	54000	54000	
	Sound pressure level (dB(A))	65.8	65.8	65.8	65.8	65.8	66.1	66.5	66.8	

3/380~415/50/60



Total pipe length 1000 m, height drop 110 m



EVI compressors



Single module 26 HP, maximum combination 104 HP



Intelligent defrosting technology



VMV-H252ARETA3
VMV-H280ARETA3
VMV-H335ARETA3
VMV-H400ARETA3
VMV-H450ARETA3



VMV-H504ARETA3
VMV-H560ARETA3
VMV-H615ARETA3
VMV-H680ARETA3
VMV-H735ARETA3

Model		VMV-H1624ARETA3	VMV-H1680ARETA3	VMV-H1735ARETA3	VMV-H1790ARETA3	VMV-H1845ARETA3	VMV-H1910ARETA3	VMV-H1975ARETA3	VMV-H2040ARETA3	
Installation	External dimensions - W/D/H (mm)	1410/750/1690 + 1410/750/1690 + 1410/750/1690								
	Shipping dimensions - W/D/H (mm)	1515/850/1858 + 1515/850/1858 + 1515/850/1858								
	Net/Shipping weight (kg)	385/410 + 385/410 + 385/410								
	Compressor type	DC INV. SCROLL								
	Compressor quantity	6INV	6INV	6INV	6INV	6INV	6INV	6INV	6INV	
	Refrigerant type	R410A								
	Refrigerant charge (kg)	30.0	30.0	30.0	30.0	30.0	30.0	30.0	30.0	
	Refrigerant liquid pipe (mm)	19.05	19.05	19.05	19.05	19.05	19.05	22.2	22.2	22.2
	Refrigerant gas pipe (mm)	41.3	41.3	41.3	41.3	41.3	41.3	44.5	44.5	44.5
	Max.total pipe length (m)	1000								
	Max. pipe length (Equivalent/Actual)	260/220								
	Max drop between I.U. & O.U. (O.U. down/up) *1 (m)	110/90								
	Standard drop between I.U. & O.U. (O.U. up/down) *2 (m)	50/40								
	Max drop between I.U. *3 (m)	30								
Standard drop between I.U. *4 (m)	18									
External static pressure (Pa)	110									
Connection ratio	Connectable indoor unit ratio (%)	50-130								
	Maximum number of indoor units	64	64	64	64	64	64	64	64	
Working temp.	Cooling (°C)	-5-52								
	Heating (°C)	-27-21								

Max drop between I.U. & O.U *1 - If the height difference between the outdoor and the indoor units is from 50 to 110 m, contact your local distributor / dealer for individual design and production.

Standard drop between I.U. & O.U *2 - Standard design and production in the factory.

Max drop between I.U. *3 - If the height difference between the indoor units is from 18 to 30 m, contact your local distributor/dealer for individual design and production.

Standard drop between I.U. *4 - Standard design and production in the factory.

* All the specifications are tested under nominal condition (in cooling, indoor temp. is 27 °C DB / 19 °C WB; Outdoor temp. 35 °C DB / 24 WB; in heating, indoor temp. is 20 °C DB, in heating, outdoor temp. is 7 °C DB / 6 °C WB).

Model		VMV-H2095ARETA3	VMV-H2150ARETA3	VMV-H2205ARETA3	VMV-H2240ARETA3	VMV-H2295ARETA3	VMV-H2350ARETA3	VMV-H2405ARETA3	
Combination model		VMV-H735ARETA3	VMV-H735ARETA3	VMV-H735ARETA3	VMV-H560ARETA3	VMV-H560ARETA3	VMV-H560ARETA3	VMV-H560ARETA3	
		VMV-H680ARETA3	VMV-H735ARETA3	VMV-H735ARETA3	VMV-H560ARETA3	VMV-H560ARETA3	VMV-H560ARETA3	VMV-H615ARETA3	
		VMV-H680ARETA3	VMV-H680ARETA3	VMV-H735ARETA3	VMV-H560ARETA3	VMV-H560ARETA3	VMV-H615ARETA3	VMV-H615ARETA3	
		-	-	-	VMV-H560ARETA3	VMV-H615ARETA3	VMV-H615ARETA3	VMV-H615ARETA3	
Capacity	Capacity range (HP)	74	76	78	80	82	84	86	
	Cooling (kW)	209.5	215.0	220.5	224.0	229.5	235.0	240.5	
	Heating (kW)	209.50	215.00	220.50	224.00	229.50	235.00	240.50	
	Heating - Max. (kW)	228.5	238.0	247.5	246.0	253.5	261.0	268.5	
Electrical parameters	Power supply (Ph/V/Hz)	3/380-415/50/60							
	Cooling	Rated power input (kW)	72.56	77.11	81.67	66.47	70.01	73.55	77.10
		Rated current (A)	103.42	108.41	113.40	115.64	118.55	121.46	124.37
		Max power input (kW)	122.50	130.19	137.87	112.21	118.19	124.18	130.16
		Max current (A)	170.15	177.94	185.73	185.20	190.81	196.42	202.03
		SEER	61.83	65.37	68.91	58.64	62.62	66.59	70.57
		$\eta_{s,c}$ (%)	93.25	95.30	97.35	98.80	99.79	100.78	101.78
	Heating	Rated power input (kW)	104.4	110.4	116.3	99.0	105.7	112.4	119.1
		Rated current (A)	155.26	158.67	162.09	164.50	166.15	167.81	169.46
		Max power input (kW)	5.15	5.15	5.15	6.75	6.54	6.54	6.54
		Max current (A)	3.5	3.5	3.5	4.2	4.2	4.2	4.2
		SCOP	203	203	203	267	259	259	259
		$\eta_{s,c}$ (%)	137	137	137	165	165	165	165
	Performance	Air flow (m ³ /h)	55000	56000	57000	68000	69000	70000	71000
Sound pressure level (dB(A))		66.8	66.8	66.8	67.0	67.0	67.0	67.0	

3/380~415/50/60



Total pipe length 1000 m, height drop 110 m



EVI compressors



Single module 26 HP, maximum combination 104 HP



Intelligent defrosting technology



VMV-H252ARETA3
VMV-H280ARETA3
VMV-H335ARETA3
VMV-H400ARETA3
VMV-H450ARETA3



VMV-H504ARETA3
VMV-H560ARETA3
VMV-H615ARETA3
VMV-H680ARETA3
VMV-H735ARETA3

Model		VMV-H2095ARETA3	VMV-H2150ARETA3	VMV-H2205ARETA3	VMV-H2240ARETA3	VMV-H2295ARETA3	VMV-H2350ARETA3	VMV-H2405ARETA3
Installation	External dimensions - W/D/H (mm)	1410/750/1690 + 1410/750/1690 + 1410/750/1690			1410/750/1690 + 1410/750/1690 + 1410/750/1690 + 1410/750/1690			
	Shipping dimensions - W/D/H (mm)	1515/850/1858 + 1515/850/1858 + 1515/850/1858			1515/850/1858 + 1515/850/1858 + 1515/850/1858 + 1515/850/1858			
	Net/Shipping weight (kg)	385/410 + 385/410 + 385/411			385/410 + 385/410 + 385/410 + 385/410			
	Compressor type	DC INV. SCROLL						
	Compressor quantity	6INV	6INV	6INV	8INV	8INV	8INV	8INV
	Refrigerant type	R410A						
	Refrigerant charge (kg)	30.0	30.0	30.0	40.0	40.0	40.0	40.0
	Refrigerant liquid pipe (mm)	22.2	22.2	22.2	22.2	22.2	22.2	25.4
	Refrigerant gas pipe (mm)	44.5	44.5	44.5	44.5	44.5	44.5	50.8
	Max.total pipe length (m)	1000						
	Max. pipe length (Equivalent/Actual)	260/220						
	Max drop between I.U. & O.U. (O.U. down/up) *1 (m)	110/90						
	Standard drop between I.U. & O.U. (O.U. up/down) *2 (m)	50/40						
	Max drop between I.U. *3 (m)	30						
Standard drop between I.U. *4 (m)	18							
External static pressure (Pa)	110							
Connection ratio	Connectable indoor unit ratio (%)	50-130						
	Maximum number of indoor units	64	64	64	64	64	64	64
Working temp.	Cooling (°C)	-5-52						
	Heating (°C)	-27-21						

Max drop between I.U. & O.U *1 - If the height difference between the outdoor and the indoor units is from 50 to 110 m, contact your local distributor / dealer for individual design and production.

Standard drop between I.U. & O.U *2 - Standard design and production in the factory.

Max drop between I.U. *3 - If the height difference between the indoor units is from 18 to 30 m, contact your local distributor/dealer for individual design and production.

Standard drop between I.U. *4 - Standard design and production in the factory.

* All the specifications are tested under nominal condition (in cooling, indoor temp. is 27 °C DB / 19 °C WB; Outdoor temp. 35 °C DB / 24 WB; in heating, indoor temp. is 20 °C DB, in heating, outdoor temp. is 7 °C DB / 6 °C WB).

Model		VMV-H2460 ARETA3	VMV-H2525 ARETA3	VMV-H2590 ARETA3	VMV-H2655 ARETA3	VMV-H2720 ARETA3	VMV-H2775 ARETA3	VMV-H2830 ARETA3	VMV-H2885 ARETA3	VMV-H2940 ARETA3	
Combination model		VMV-H615ARETA3	VMV-H680ARETA3	VMV-H680ARETA3	VMV-H680ARETA3	VMV-H680ARETA3	VMV-H735ARETA3	VMV-H735ARETA3	VMV-H735ARETA3	VMV-H735ARETA3	
		VMV-H615ARETA3	VMV-H615ARETA3	VMV-H680ARETA3	VMV-H680ARETA3	VMV-H680ARETA3	VMV-H680ARETA3	VMV-H735ARETA3	VMV-H735ARETA3	VMV-H735ARETA3	
		VMV-H615ARETA3	VMV-H615ARETA3	VMV-H615ARETA3	VMV-H680ARETA3	VMV-H680ARETA3	VMV-H680ARETA3	VMV-H680ARETA3	VMV-H735ARETA3	VMV-H735ARETA3	
		VMV-H615ARETA3	VMV-H615ARETA3	VMV-H615ARETA3	VMV-H615ARETA3	VMV-H680ARETA3	VMV-H680ARETA3	VMV-H680ARETA3	VMV-H680ARETA3	VMV-H735ARETA3	
Capacity	Capacity range (HP)	88	90	92	94	96	98	100	102	104	
	Cooling (kW)	246.0	252.5	259.0	265.5	272.0	277.5	283.0	288.5	294.0	
	Heating (kW)	246.00	252.50	259.00	265.50	272.00	277.50	283.00	288.50	294.00	
	Heating - Max. (kW)	276.0	280.0	284.0	288.0	292.0	301.5	311.0	320.5	330.0	
Electrical parameters	Power supply (Ph/V/Hz)	3/380-415/50/60									
	Cooling	Rated power input (kW)	80.64	83.15	85.66	88.17	90.68	95.23	99.78	104.34	108.89
		Rated current (A)	127.28	128.27	129.26	130.25	131.24	136.23	141.22	146.21	151.20
		Max power input (kW)	136.14	140.37	144.61	148.85	153.09	160.77	168.46	176.14	183.83
		Max current (A)	207.64	209.85	212.06	214.27	216.48	224.27	232.06	239.85	247.64
		SEER	74.55	75.34	76.13	76.92	77.71	81.25	84.79	88.33	91.88
	$\eta_{s,c}$ (%)	102.77	107.48	112.18	116.89	121.60	123.65	125.70	127.75	129.80	
	Heating	Rated power input (kW)	125.8	127.2	128.5	129.9	131.2	137.2	143.2	149.1	155.1
		Rated current (A)	171.11	178.95	186.79	194.63	202.46	205.88	209.29	212.70	216.12
		Max power input (kW)	6.54	5.83	5.83	5.83	5.83	5.15	5.15	5.15	5.15
		Max current (A)	4.21	4.17	4.17	4.17	4.17	3.5	3.5	3.5	3.5
		SCOP	259	230	230	230	230	203	203	203	203
		$\eta_{s,c}$ (%)	165	164	164	164	164	137	137	137	137
Performance	Air flow (m ³ /h)	72000	72000	72000	72000	72000	73000	74000	75000	76000	
	Sound pressure level (dB(A))	67.0	67.3	67.5	67.8	67.0	67.3	67.5	67.8	68.0	

3/380~415/50/60



Total pipe length 1000 m, height drop 110 m



EVI compressors



Single module 26 HP, maximum combination 104 HP



Intelligent defrosting technology



VMV-H2525ARETA3
VMV-H280ARETA3
VMV-H335ARETA3
VMV-H400ARETA3
VMV-H450ARETA3



VMV-H504ARETA3
VMV-H560ARETA3
VMV-H615ARETA3
VMV-H680ARETA3
VMV-H735ARETA3

Model		VMV-H2460 ARETA3	VMV-H2525 ARETA3	VMV-H2590 ARETA3	VMV-H2655 ARETA3	VMV-H2720 ARETA3	VMV-H2775 ARETA3	VMV-H2830 ARETA3	VMV-H2885 ARETA3	VMV-H2940 ARETA3
Installation	External dimensions - W/D/H (mm)	1410/750/1690 + 1410/750/1690 + 1410/750/1690 + 1410/750/1690								
	Shipping dimensions - W/D/H (mm)	1515/850/1858 + 1515/850/1858 + 1515/850/1858 + 1515/850/1858								
	Net/Shipping weight (kg)	385/410 + 385/410 + 385/410 + 385/410								
	Compressor type	DC INV. SCROLL								
	Compressor quantity	8INV	8INV	8INV	8INV	8INV	8INV	8INV	8INV	8INV
	Refrigerant type	R410A								
	Refrigerant charge (kg)	40.0	40.0	40.0	40.0	40.0	40.0	40.0	40.0	40.0
	Refrigerant liquid pipe (mm)	25.4	25.4	25.4	25.4	25.4	25.4	25.4	25.4	25.4
	Refrigerant gas pipe (mm)	50.8	50.8	50.8	50.8	50.8	50.8	54.1	54.1	54.1
	Max.total pipe length (m)	1000								
	Max. pipe length (Equivalent/Actual)	260/220								
	Max drop between I.U. & O.U. (O.U. down/up) *1 (m)	110/90								
	Standard drop between I.U. & O.U. (O.U. up/down) *2 (m)	50/40								
	Max drop between I.U. *3 (m)	30								
Standard drop between I.U. *4 (m)	18									
External static pressure (Pa)	110									
Connection ratio	Connectable indoor unit ratio (%)	50-130								
	Maximum number of indoor units	64	64	64	64	64	64	64	64	64
Working temp.	Cooling (°C)	-5-52								
	Heating (°C)	-27-21								

Max drop between I.U. & O.U *1 - If the height difference between the outdoor and the indoor units is from 50 to 110 m, contact your local distributor / dealer for individual design and production.

Standard drop between I.U. & O.U *2 - Standard design and production in the factory.

Max drop between I.U. *3 - If the height difference between the indoor units is from 18 to 30 m, contact your local distributor/dealer for individual design and production.

Standard drop between I.U. *4 - Standard design and production in the factory.

* All the specifications are tested under nominal condition (in cooling, indoor temp. is 27 °C DB / 19 °C WB; Outdoor temp. 35 °C DB / 24 WB; in heating, indoor temp. is 20 °C DB, in heating, outdoor temp. is 7 °C DB / 6 °C WB).

VMM5R

DC INVERTER



Advanced
technology



High
efficiency



Easy
installation



System introduction

What is VRF heat recovery system?

In the ordinary, two-pipe VRF system, all indoor units within the same system can operate either only in cooling, or only in heating mode. Indoor units in the VMV 5R heat recovery system can simultaneously operate in both cooling, and heating mode using third, heat recovery pipe and valve boxes.

2-pipe system

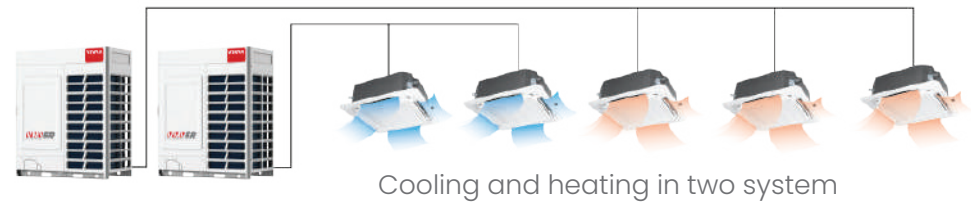

3-pipe system

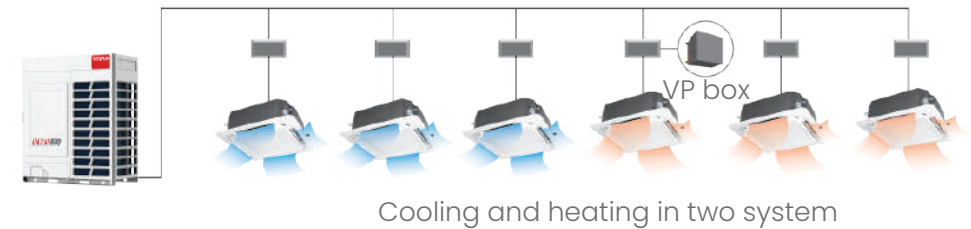

Variable operation mode in one system

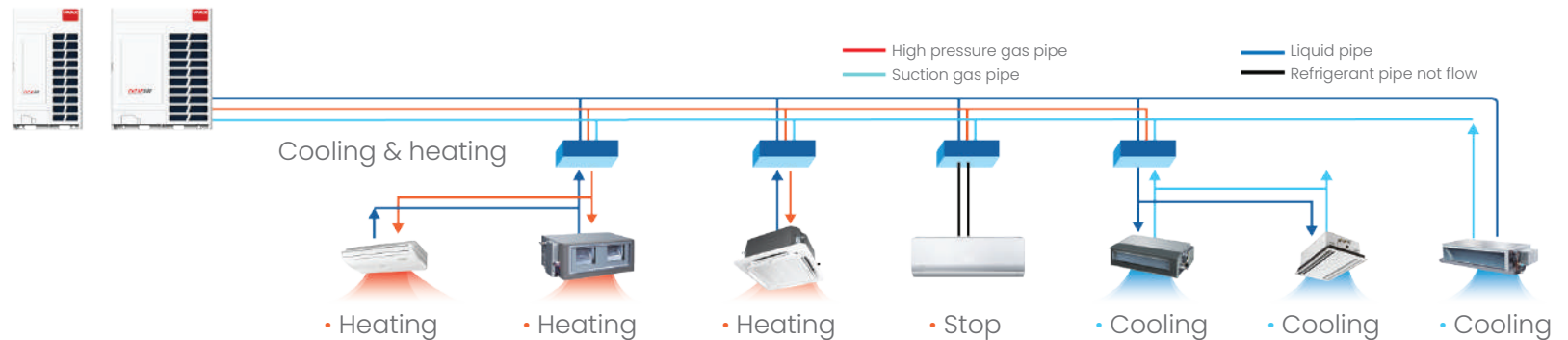

System introduction



High efficiency

Full DC inverter technology

VMV 5R series is equipped with a full DC inverter compressor and a fan with stepless DC inverter motor which increase the overall system efficiency.

Two stage sub-cooling technology

VMV 5R series is equipped with a refrigerant sub-cooler which improves the system capacity and overall performance.

Double pressure sensors

High and low pressure sensors ensure real-time feedback regarding the suction and discharge pressure which enables quicker start of the compressor and the more accurate control.

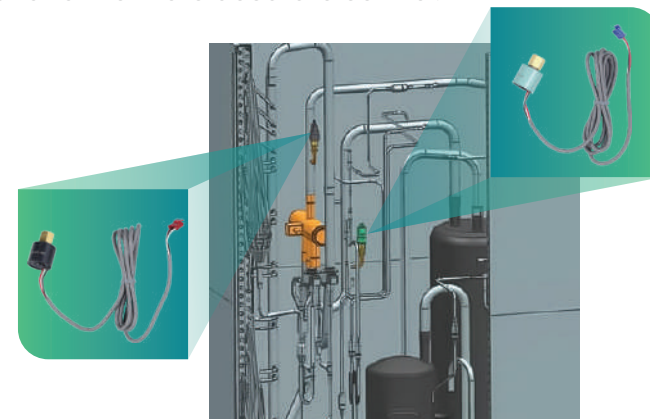

Easy installation

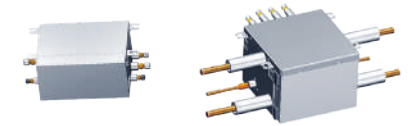

Valve pipe box overview

Valve pipe box is specially designed for VMV 5R series. Small volume of only 0,02 m³ (0,047m³ for VPB-04REA4) makes it perfect for installation in restricted spaces. The valve pipe boxes could be connected in series which simplifies the installation and reduce the installation cost.

Model name	Max.capacity of indoor (kw)	Power Supply	Max. indoor units	Dimension (mm)
VPB-01REA1	$x \leq 11.2$	1/220~240/50/60	5	388 × 200 × 275
VPB-02REA1	$11.2 < x \leq 18$	1/220~240/50/60	8	388 × 200 × 275
VPB-03REA1	$18 < x \leq 28$	1/220~240/50/60	8	388 × 200 × 275
VPB-04REA4	≤ 45	1/220~240/50/60	20	396 × 290 × 411

Easy access for maintenance and repair

Rotating design of the electronic control box allows easy access to all internal system components, and saves time during maintenance.



Auto addressing indoor units

The outdoor unit can automatically address the indoor units through the module on the PCB. It is more convenient and time saving as there is no need to manually set the addresses on each indoor units separately.

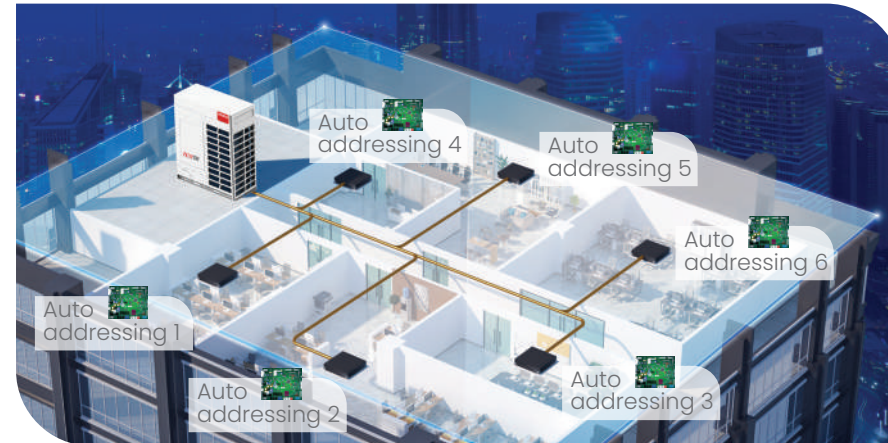

Automatic oil balancing

In the multi module outdoor system the oil level in every module is balanced automatically. In such system there is no need for oil balancing pipes which simplifies the system design and improves reliability.



Model		VMV-R224ARETA3	VMV-R280ARETA3	VMV-R335ARETA3	VMV-R400ARETA3	
Combination model		-	-	-	-	
		-	-	-	-	
		-	-	-	-	
		-	-	-	-	
Capacity	Capacity range (HP)	8	10	12	14	
	Cooling (kW)	22.4	28.0	33.5	40.0	
	Heating (kW)	22.4	28.0	33.5	40.0	
	Heating - Max. (kW)	25.00	31.50	37.50	45.00	
Electrical parameters	Power supply (Ph/V/Hz)	3/380-415/50/60	3/380-415/50/60	3/380-415/50/60	3/380-415/50/60	
	Cooling	Rated power input (kW)	5.83	7.67	9.94	12.31
		Max power input (kW)	12.80	13.80	18.20	19.20
		Rated current (A)	9.63	12.67	16.43	20.33
		Max current (A)	21.14	22.79	30.06	31.71
	Heating	Rated power input (kW)	5.4	6.7	8.8	10.5
		Max power input (kW)	11.50	12.50	17.40	18.40
		Rated current (A)	8.88	11.01	14.48	17.38
		Max current (A)	18.99	20.64	28.74	30.39
	SEER	6.12	6.68	6.46	6.37	
	SCOP	3.82	3.94	3.99	3.86	
	$\eta_{s,c}$ (%)	242	264	255	252	
	$\eta_{s,c}$ (%)	150	155	157	151	
	Performance	Air flow (m ³ /h)	11000.00	11000.00	12000.00	13500.00
Sound pressure level (dB(A))		56	56	59	59	

3/380~415/50/60



VMV-R224ARETA3
VMV-R280ARETA3
VMV-R335ARETA3
VMV-R400ARETA3



VMV-R450ARETA3
VMV-R500ARETA3
VMV-R560ARETA3
VMV-R600ARETA3

Model		VMV-R224ARETA3	VMV-R280ARETA3	VMV-R335ARETA3	VMV-R400ARETA3
Installation	External dimensions - W/D/H (mm)	980/1690/750			
	Shipping dimensions - W/D/H (mm)	1070/1858/850			
	Net/Shipping weight (kg)	224/250		257/282	
	Compressor type	DC INV. SCROLL			
	Compressor quantity	1			
	Refrigerant type	R410A			
	Refrigerant charge (kg)	10.0	10.0	10.0	10.0
	Refrigerant liquid pipe (mm)	9.52	9.52	12.70	12.70
	Refrigerant gas pipe (mm)	19.05	22.22	25.40	25.40
	Refrigerant high gas pipe (mm)	19.05	19.05	22.22	22.22
	Max.total pipe lenth (m)	1000			
	Max. pipe length (Equivalent/Actual)	260/220			
	Max drop between I.U. & O.U. (O.U. down/up) *1 (m)	110/90			
	Standard drop between I.U. & O.U. (O.U. up/down) *2 (m)	50/40			
	Max drop between I.U. *3 (m)	30			
	Standard drop between I.U. *4 (m)	18			
External static pressure (Pa)	110				
Connection ratio	Connectable indoor unit ratio (%)	50-130			
	Maximum number of indoor units	13	16	20	24
Working temp.	Cooling (°C)	-5-50			
	Heating (°C)	-23-21			

Max drop between I.U. & O.U *1 - If the height difference between the outdoor and the indoor units is from 50 to 110 m, contact your local distributor / dealer for individual design and production.

Standard drop between I.U. & O.U *2 - Standard design and production in the factory.

Max drop between I.U. *3 - If the height difference between the indoor units is from 18 to 30 m, contact your local distributor/dealer for individual design and production.

Standard drop between I.U. *4 - Standard design and production in the factory.

* All the specifications are tested under nominal condition (in cooling, indoor temp. is 27 °C DB / 19 °C WB; Outdoor temp. 35 °C DB / 24 WB; in heating, indoor temp. is 20 °C DB, in heating, outdoor temp. is 7 °C DB / 6 °C WB).

Model		VMV-R450ARETA3	VMV-R500ARETA3	VMV-R560ARETA3	VMV-R600ARETA3	VMV-R670ARETA3	VMV-R735ARETA3	VMV-R800ARETA3	VMV-R850ARETA3	
Combination model		-	-	-	-	VMV-R335ARETA3	VMV-R335ARETA3	VMV-R400ARETA3	VMV-R400ARETA3	
		-	-	-	-	VMV-R335ARETA3	VMV-R400ARETA3	VMV-R400ARETA3	VMV-R450ARETA3	
		-	-	-	-	-	-	-	-	
		-	-	-	-	-	-	-	-	
Capacity	Capacity range (HP)	16	18	20	22	24	26	28	30	
	Cooling (kW)	45.0	50.0	56.0	60.0	67.0	73.5	80.0	85.0	
	Heating (kW)	45.0	50.0	56.0	60.0	67.0	73.5	80.0	85.0	
	Heating - Max. (kW)	50.00	56.00	61.50	69.00	75.00	82.50	90.0	95.0	
Electrical parameters	Power supply (Ph/V/Hz)	3/380~415/50/60								
	Cooling	Rated power input (kW)	13.93	16.13	18.67	20.00	19.88	22.25	24.62	26.24
		Max power input (kW)	25.10	28.50	32.00	33.00	36.40	37.40	38.40	44.30
		Rated current (A)	23.01	26.64	30.83	33.03	32.83	36.74	40.65	43.33
		Max current (A)	41.45	47.07	52.85	54.50	60.11	61.77	63.42	73.16
	Heating	Rated power input (kW)	11.4	13.7	15.8	17.9	17.5	19.3	21.1	21.9
		Max power input (kW)	22.70	25.50	29.40	30.40	34.80	35.80	36.80	41.10
		Rated current (A)	18.81	22.62	26.05	29.58	28.97	31.87	34.8	36.2
		Max current (A)	37.49	42.11	48.55	50.21	57.47	59.12	60.78	67.88
	SEER	6.86	6.48	4.73	5.63	6.46	6.37	6.37	6.37	
	SCOP	4.21	3.99	3.91	3.50	3.99	3.86	3.86	3.86	
	ηs,c (%)	271	256	186	222	255	252	252	252	
ηs,c (%)	165	157	153	137	157	151	151	151		
Performance	Air flow (m³/h)	13500.00	17000.00	17000.00	18000.00	18000.00	19000.00	27000.00	27000.00	
	Sound pressure level (dB(A))	60	61	61	61	62	62	62	63	

3/380~415/50/60



Total pipe length 1000 m, height drop 110 m



Full DC inverter compressors



Single module 22HP, maximum combination 88HP



Automatic Oil balancing



VMV-R224ARETA3
VMV-R280ARETA3
VMV-R335ARETA3
VMV-R400ARETA3



VMV-R450ARETA3
VMV-R500ARETA3
VMV-R560ARETA3
VMV-R600ARETA3

Model		VMV-R450ARETA3	VMV-R500ARETA3	VMV-R560ARETA3	VMV-R600ARETA3	VMV-R670ARETA3	VMV-R735ARETA3	VMV-R800ARETA3	VMV-R850ARETA3	
Installation	External dimensions - W/D/H (mm)	1410/1690/750				980/750/1690 + 980/750/1690			980/750/1690 + 1410/750/1690	
	Shipping dimensions - W/D/H (mm)	1515/1858/850				1070/850/1858 + 1070/850/1858			1070/850/1858 + 1515/850/1858	
	Net/Shipping weight (kg)	366/395		375/404		514/564			623/677	
	Compressor type	DC INV. SCROLL								
	Compressor quantity	1	1	2	2	2	2	2	2	
	Refrigerant type	R410A								
	Refrigerant charge (kg)	10.0	10.0	10.0	10.0	20.0	20.0	20.0	20.0	
	Refrigerant liquid pipe (mm)	12.70	15.88	15.88	15.88	15.88	15.88	15.88	19.05	
	Refrigerant gas pipe (mm)	28.58	28.58	28.58	28.58	28.58	28.58	28.58	31.8	
	Refrigerant high gas pipe (mm)	25.4	25.4	25.4	25.4	25.4	25.4	25.4	28.58	
	Max.total pipe lenth (m)	1000								
	Max. pipe length (Equivalent/Actual)	260/220								
	Max drop between I.U. & O.U. (O.U. down/up) *1 (m)	110/90								
	Standard drop between I.U. & O.U. (O.U. up/down) *2 (m)	50/40								
	Max drop between I.U. *3 (m)	30								
Standard drop between I.U. *4 (m)	18									
External static pressure (Pa)	110									
Connection ratio	Connectable indoor unit ratio (%)	50-130								
	Maximum number of indoor units	27	30	33	36	40	43	46	50	
Working temp.	Cooling (°C)	-5~50								
	Heating (°C)	-23~21								

Max drop between I.U. & O.U *1 - If the height difference between the outdoor and the indoor units is from 50 to 110 m, contact your local distributor / dealer for individual design and production.

Standard drop between I.U. & O.U *2 - Standard design and production in the factory.

Max drop between I.U. *3 - If the height difference between the indoor units is from 18 to 30 m, contact your local distributor/dealer for individual design and production.

Standard drop between I.U. *4 - Standard design and production in the factory.

* All the specifications are tested under nominal condition(in cooling, indoor temp. is 27 °C DB / 19 °C WB; Outdoor temp. 35 °C DB / 24 WB; in heating, indoor temp. is 20 °C DB, in heating, outdoor temp. is 7 °C DB / 6 °C WB).

Model		VMV-R900ARETA3	VMV-R950ARETA3	VMV-R1000ARETA3	VMV-R1060ARETA3	VMV-R1120ARETA3	VMV-R1160ARETA3	VMV-R1200ARETA3	VMV-R1300ARETA3	
Combination model		VMV-R450ARETA3	VMV-R450ARETA3	VMV-R500ARETA3	VMV-R500ARETA3	VMV-R560ARETA3	VMV-R560ARETA3	VMV-R600ARETA3	VMV-R400ARETA3	
		VMV-R450ARETA3	VMV-R500ARETA3	VMV-R500ARETA3	VMV-R560ARETA3	VMV-R560ARETA3	VMV-R600ARETA3	VMV-R600ARETA3	VMV-R450ARETA3	
		-	-	-	-	-	-	-	VMV-R450ARETA3	
		-	-	-	-	-	-	-	-	
Capacity	Capacity range (HP)	32	34	36	38	40	42	44	46	
	Cooling (kW)	90.0	95.0	100.0	106.0	112.0	116.0	120.0	130.0	
	Heating (kW)	90.0	95.0	100.0	106.0	112.0	116.0	120.0	130.0	
	Heating - Max. (kW)	100.0	106.0	112.0	117.5	123.0	130.5	138.0	145.0	
Electrical parameters	Power supply (Ph/V/Hz)	3/380-415/50/60								
	Cooling	Rated power input (kW)	27.86	30.06	32.26	34.80	37.33	38.67	40.00	40.17
		Max power input (kW)	50.20	53.60	57.00	60.50	64.00	65.00	66.00	69.40
		Rated current (A)	46.02	49.65	53.27	57.47	61.66	63.86	66.06	66.34
		Max current (A)	82.91	88.52	94.14	99.92	105.70	107.35	109.00	114.61
	Heating	Rated power input (kW)	22.8	25.1	27.4	29.5	31.5	33.7	35.8	33.3
		Max power input (kW)	45.40	48.20	51.00	54.90	58.80	59.80	60.80	63.80
		Rated current (A)	37.6	41.4	45.2	48.7	52.1	55.6	59.2	55.0
		Max current (A)	74.98	79.60	84.23	90.67	97.11	98.76	100.41	105.37
	SEER	6.86	6.48	6.48	4.73	4.73	4.73	4.73	5.63	6.37
	SCOP	4.21	3.99	3.99	3.91	3.91	3.91	3.5	3.5	3.86
	ηs,c (%)	271	256	256	186	186	186	186	222	252
	ηs,c (%)	165	157	157	153	153	153	137	137	151
Performance	Air flow (m³/h)	27000	30500	34000	34000	34000	35000	36000	36000	
	Sound pressure level (dB(A))	63	64	64	64	64	64	64	65	

3/380~415/50/60



Total pipe length 1000 m, height drop 110 m



Full DC inverter compressors



Single module 22HP, maximum combination 88HP



Automatic Oil balancing



VMV-R224ARETA3
VMV-R280ARETA3
VMV-R335ARETA3
VMV-R400ARETA3



VMV-R450ARETA3
VMV-R500ARETA3
VMV-R560ARETA3
VMV-R600ARETA3

Model		VMV-R900A- RETA3	VMV-R950A- RETA3	VMV-R1000A- RETA3	VMV-R1060A- RETA3	VMV-R1120A- RETA3	VMV-R1160A- RETA3	VMV-R1200A- RETA3	VMV-R1300ARETA3
Installation	External dimensions - W/D/H (mm)	1410/750/1690 + 1410/750/1690							980/750/1690 + 1410/750/1690 + 1410/750/1690
	Shipping dimensions - W/D/H (mm)	1515/850/1858 + 1515/850/1858							1070/850/1858 + 1515/850/1858 + 1515/850/1858
	Net/Shipping weight (kg)	732/790			741/799	750/808			989/1072
	Compressor type	DC INV. SCROLL							
	Compressor quantity	2	2	2	3	4	4	4	4
	Refrigerant type	R410A							
	Refrigerant charge (kg)	20.0	20.0	20.0	20.0	20.0	20.0	20.0	30.0
	Refrigerant liquid pipe (mm)	19.05	19.05	19.05	19.05	19.05	19.05	19.05	19.05
	Refrigerant gas pipe (mm)	31.8	31.8	38.1	38.1	38.1	38.1	38.1	38.1
	Refrigerant high gas pipe (mm)	28.58	28.58	31.8	31.8	31.8	31.8	31.8	31.8
	Max.total pipe lenth (m)	1000							
	Max. pipe length (Equivalent/Actual)	260/220							
	Max drop between I.U. & O.U. (O.U. down/up) *1 (m)	110/90							
	Standard drop between I.U. & O.U. (O.U. up/down) *2 (m)	50/40							
	Max drop between I.U. *3 (m)	30							
Standard drop between I.U. *4 (m)	18								
External static pressure (Pa)	110								
Connection ratio	Connectable indoor unit ratio (%)	50-130							
	Maximum number of indoor units	53	57	60	64	64	64	64	64
Working temp.	Cooling (°C)	-5-50							
	Heating (°C)	-23~21							

Max drop between I.U. & O.U *1 - If the height difference between the outdoor and the indoor units is from 50 to 110 m, contact your local distributor / dealer for individual design and production.

Standard drop between I.U. & O.U *2 - Standard design and production in the factory.

Max drop between I.U. *3 - If the height difference between the indoor units is from 18 to 30 m, contact your local distributor/dealer for individual design and production.

Standard drop between I.U. *4 - Standard design and production in the factory.

* All the specifications are tested under nominal condition(in cooling, indoor temp. is 27 °C DB / 19 °C WB; Outdoor temp. 35 °C DB / 24 WB; in heating, indoor temp. is 20 °C DB, in heating, outdoor temp. is 7 °C DB / 6 °C WB).

Model		VMV-R1350ARETA3	VMV-R1400ARETA3	VMV-R1450ARETA3	VMV-R1500ARETA3	VMV-R1560ARETA3	VMV-R1620ARETA3	VMV-R1680ARETA3	
Combination model		VMV-R450ARETA3	VMV-R450ARETA3	VMV-R450ARETA3	VMV-R500ARETA3	VMV-R500ARETA3	VMV-R500ARETA3	VMV-R560ARETA3	
		VMV-R450ARETA3	VMV-R450ARETA3	VMV-R500ARETA3	VMV-R500ARETA3	VMV-R500ARETA3	VMV-R560ARETA3	VMV-R560ARETA3	
		VMV-R450ARETA3	VMV-R500ARETA3	VMV-R500ARETA3	VMV-R500ARETA3	VMV-R560ARETA3	VMV-R560ARETA3	VMV-R560ARETA3	
		-	-	-	-	-	-	-	
Capacity	Capacity range (HP)	48	50	52	54	56	58	60	
	Cooling (kW)	135.0	140.0	145.0	150.0	156.0	162.0	168.0	
	Heating (kW)	135.0	140.0	145.0	150.0	156.0	162.0	168.0	
	Heating - Max. (kW)	150.0	156.0	162.0	168.0	173.5	179.0	184.5	
Electrical parameters	Power supply (Ph/V/Hz)	3/380-415/50/60							
	Cooling	Rated power input (kW)	41.80	43.99	46.19	48.39	50.92	53.46	56.00
		Max power input (kW)	75.30	78.70	82.10	85.50	89.00	92.50	96.00
		Rated current (A)	69.03	72.65	76.28	79.91	84.10	88.29	92.48
		Max current (A)	124.36	129.97	135.59	141.20	146.98	152.76	158.54
	Heating	Rated power input (kW)	34.2	36.5	38.8	41.1	43.2	45.2	47.3
		Max power input (kW)	68.10	70.90	73.70	76.50	80.40	84.30	88.20
		Rated current (A)	56.4	60.3	64.1	67.9	71.3	74.7	78.1
		Max current (A)	112.47	117.09	121.72	126.34	132.78	139.22	145.66
	SEER		6.86	6.48	6.48	6.48	4.73	4.73	4.73
	SCOP		4.21	3.99	3.99	3.99	3.91	3.91	3.91
	ηs,c (%)		271	256	256	256	186	186	186
	ηs,c (%)		165	157	157	157	153	153	153
Performance	Air flow (m³/h)	36000	37000	38000	51000	51000	51000	51000	
	Sound pressure level (dB(A))	65	65	65	66	66	66	66	

3/380~415/50/60



Total pipe length 1000 m, height drop 110 m



Full DC inverter compressors



Single module 22HP, maximum combination 88HP



Automatic Oil balancing



VMV-R224ARETA3
VMV-R280ARETA3
VMV-R335ARETA3
VMV-R400ARETA3



VMV-R450ARETA3
VMV-R500ARETA3
VMV-R560ARETA3
VMV-R600ARETA3

Model		VMV-R1350ARETA3	VMV-R1400ARETA3	VMV-R1450ARETA3	VMV-R1500ARETA3	VMV-R1560ARETA3	VMV-R1620ARETA3	VMV-R1680ARETA3
Installation	External dimensions - W/D/H (mm)	1410/750/1690 + 1410/750/1690 + 1410/750/1690						
	Shipping dimensions - W/D/H (mm)	1515/850/1858 + 1515/850/1858 + 1515/850/1858						
	Net/Shipping weight (kg)	1098/1185				1107/1194	1116/1203	1125/1212
	Compressor type	DC INV. SCROLL						
	Compressor quantity	4	4	4	3	4	5	6
	Refrigerant type	R410A						
	Refrigerant charge (kg)	30.0	30.0	30.0	30.0	30.0	30.0	30.0
	Refrigerant liquid pipe (mm)	19.05	19.05	19.05	19.05	19.05	19.05	19.05
	Refrigerant gas pipe (mm)	38.1	38.1	38.1	38.1	38.1	41.3	41.3
	Refrigerant high gas pipe (mm)	31.8	31.8	31.8	31.8	31.8	38.1	38.1
	Max.total pipe length (m)	1000						
	Max. pipe length (Equivalent/Actual)	260/220						
	Max drop between I.U. & O.U. (O.U. down/up) *1 (m)	110/90						
	Standard drop between I.U. & O.U. (O.U. up/down) *2 (m)	50/40						
	Max drop between I.U. *3 (m)	30						
Standard drop between I.U. *4 (m)	18							
External static pressure (Pa)	110							
Connection ratio	Connectable indoor unit ratio (%)	50-130						
	Maximum number of indoor units	64	64	64	64	64	64	64
Working temp.	Cooling (°C)	-5-50						
	Heating (°C)	-23-21						

Max drop between I.U. & O.U *1 - If the height difference between the outdoor and the indoor units is from 50 to 110 m, contact your local distributor / dealer for individual design and production.

Standard drop between I.U. & O.U *2 - Standard design and production in the factory.

Max drop between I.U. *3 - If the height difference between the indoor units is from 18 to 30 m, contact your local distributor/dealer for individual design and production.

Standard drop between I.U. *4 - Standard design and production in the factory.

* All the specifications are tested under nominal condition (in cooling, indoor temp. is 27 °C DB / 19 °C WB; Outdoor temp. 35 °C DB / 24 °C WB; in heating, indoor temp. is 20 °C DB, in heating, outdoor temp. is 7 °C DB / 6 °C WB).

Model		VMV-R1720ARETA3	VMV-R1760ARETA3	VMV-R1800ARETA3	VMV-R1900ARETA3	VMV-R1950ARETA3	VMV-R2000ARETA3	
Combination model		VMV-R560ARETA3	VMV-R560ARETA3	VMV-R600ARETA3	VMV-R450ARETA3	VMV-R450ARETA3	VMV-R500ARETA3	
		VMV-R560ARETA3	VMV-R600ARETA3	VMV-R600ARETA3	VMV-R450ARETA3	VMV-R500ARETA3	VMV-R500ARETA3	
		VMV-R600ARETA3	VMV-R600ARETA3	VMV-R600ARETA3	VMV-R500ARETA3	VMV-R500ARETA3	VMV-R500ARETA3	
		-	-	-	VMV-R500ARETA3	VMV-R500ARETA3	VMV-R500ARETA3	
Capacity	Capacity range (HP)	62	64	66	68	70	72	
	Cooling (kW)	172.0	176.0	180.0	190.0	195.0	200.0	
	Heating (kW)	172.0	176.0	180.0	190.0	195.0	200.0	
	Heating - Max. (kW)	192.0	199.5	207.0	212.0	218.0	224.0	
Electrical parameters	Power supply (Ph/V/Hz)	3/380-415/50/60						
	Cooling	Rated power input (kW)	57.33	58.67	60.00	60.12	62.32	64.52
		Max power input (kW)	97.00	98.00	99.00	107.20	110.60	114.00
		Rated current (A)	94.69	96.89	99.09	99.29	102.92	106.55
		Max current (A)	160.20	161.85	163.50	177.04	182.66	188.27
	Heating	Rated power input (kW)	49.5	51.6	53.7	50.2	52.5	54.8
		Max power input (kW)	89.20	90.20	91.20	96.40	99.20	102.00
		Rated current (A)	81.7	85.2	88.7	82.9	86.7	90.5
		Max current (A)	147.31	148.97	150.62	159.21	163.83	168.45
	SEER	4.73	4.73	5.63	6.48	6.48	6.48	
	SCOP	3.5	3.5	3.5	3.99	3.99	3.99	
	ηs,c (%)	186	186	222	256	256	256	
ηs,c (%)	137	137	137	157	157	157		
Performance	Air flow (m³/h)	52000	53000	54000	54000	54000	54000	
	Sound pressure level (dB(A))	66	66	66	66	66	67	

3/380~415/50/60



Total pipe length 1000 m, height drop 110 m



Full DC inverter compressors



Single module 22HP, maximum combination 88HP



Automatic Oil balancing



VMV-R224ARETA3
VMV-R280ARETA3
VMV-R335ARETA3
VMV-R400ARETA3



VMV-R450ARETA3
VMV-R500ARETA3
VMV-R560ARETA3
VMV-R600ARETA3

Model		VMV-R1720ARETA3	VMV-R1760ARETA3	VMV-R1800ARETA3	VMV-R1900ARETA3	VMV-R1950ARETA3	VMV-R2000ARETA3
Installation	External dimensions - W/D/H (mm)	1410/750/1690 + 1410/750/1690 + 1410/750/1690			1410/750/1690 + 1410/750/1690 + 1410/750/1690 + 1410/750/1690		
	Shipping dimensions - W/D/H (mm)	1515/850/1858 + 1515/850/1858 + 1515/850/1858			1515/850/1858 + 1515/850/1858 + 1515/850/1858 + 1515/850/1858		
	Net/Shipping weight (kg)	1125/1212			1464/1580		
	Compressor type	DC INV. SCROLL					
	Compressor quantity	6	6	6	6	6	6
	Refrigerant type	R410A					
	Refrigerant charge (kg)	30.0	30.0	30.0	40.0	40.0	40.0
	Refrigerant liquid pipe (mm)	19.05	19.05	19.05	22.2	22.2	22.2
	Refrigerant gas pipe (mm)	41.3	41.3	41.3	44.5	44.5	44.5
	Refrigerant high gas pipe (mm)	38.1	38.1	38.1	41.3	41.3	41.3
	Max.total pipe length (m)	1000					
	Max. pipe length (Equivalent/Actual)	260/220					
	Max drop between I.U. & O.U. (O.U. down/up) *1 (m)	110/90					
	Standard drop between I.U. & O.U. (O.U. up/down) *2 (m)	50/40					
	Max drop between I.U. *3 (m)	30					
Standard drop between I.U. *4 (m)	18						
External static pressure (Pa)	110						
Connection ratio	Connectable indoor unit ratio (%)	50-130					
	Maximum number of indoor units	64	64	64	64	64	64
Working temp.	Cooling (°C)	-5-50					
	Heating (°C)	-23-21					

Max drop between I.U. & O.U *1 - If the height difference between the outdoor and the indoor units is from 50 to 110 m, contact your local distributor / dealer for individual design and production.

Standard drop between I.U. & O.U *2 - Standard design and production in the factory.

Max drop between I.U. *3 - If the height difference between the indoor units is from 18 to 30 m, contact your local distributor/dealer for individual design and production.

Standard drop between I.U. *4 - Standard design and production in the factory.

* All the specifications are tested under nominal condition (in cooling, indoor temp. is 27 °C DB / 19 °C WB; Outdoor temp. 35 °C DB / 24 WB; in heating, indoor temp. is 20 °C DB, in heating, outdoor temp. is 7 °C DB / 6 °C WB).

Model		VMV-R2060ARETA3	VMV-R2120ARETA3	VMV-R2180ARETA3	VMV-R2240ARETA3	
Combination model		VMV-R500ARETA3	VMV-R500ARETA3	VMV-R500ARETA3	VMV-R560ARETA3	
		VMV-R500ARETA3	VMV-R500ARETA3	VMV-R560ARETA3	VMV-R560ARETA3	
		VMV-R500ARETA3	VMV-R560ARETA3	VMV-R560ARETA3	VMV-R560ARETA3	
		VMV-R560ARETA3	VMV-R560ARETA3	VMV-R560ARETA3	VMV-R560ARETA3	
Capacity	Capacity range (HP)	74	76	78	80	
	Cooling (kW)	206.0	212.0	218.0	224.0	
	Heating (kW)	206.0	212.0	218.0	224.0	
	Heating - Max. (kW)	229.5	235.0	240.5	246.0	
Electrical parameters	Power supply (Ph/V/Hz)	3/380~415/50/60				
	Cooling	Rated power input (kW)	67.05	69.59	72.13	74.67
		Max power input (kW)	117.50	121.00	124.50	128.00
		Rated current (A)	110.74	114.93	119.12	123.31
		Max current (A)	194.05	199.83	205.61	211.39
	Heating	Rated power input (kW)	56.9	58.9	61.0	63.1
		Max power input (kW)	105.90	109.80	113.70	117.60
		Rated current (A)	93.9	97.3	100.8	104.2
		Max current (A)	174.89	181.34	187.78	194.22
	SEER	4.73	4.73	4.73	4.73	
	SCOP	3.91	3.91	3.91	3.91	
	ηs,c (%)	186	186	186	186	
	ηs,c (%)	153	153	153	153	
Performance	Air flow (m³/h)	55000	56000	57000	68000	
	Sound pressure level (dB(A))	67	67	67	67	

3/380~415/50/60



Total pipe length 1000 m, height drop 110 m



Full DC inverter compressors



Single module 22HP, maximum combination 88HP



Automatic Oil balancing



VMV-R224ARETA3
VMV-R280ARETA3
VMV-R335ARETA3
VMV-R400ARETA3



VMV-R450ARETA3
VMV-R500ARETA3
VMV-R560ARETA3
VMV-R600ARETA3

Model		VMV-R2060ARETA3	VMV-R2120ARETA3	VMV-R2180ARETA3	VMV-R2240ARETA3
Installation	External dimensions - W/D/H (mm)	1410/750/1690 + 1410/750/1690 + 1410/750/1690 + 1410/750/1690			
	Shipping dimensions - W/D/H (mm)	1515/850/1858 + 1515/850/1858 + 1515/850/1858 + 1515/850/1858			
	Net/Shipping weight (kg)	1473/1589	1482/1598	1491/1607	1500/1616
	Compressor type	DC INV. SCROLL			
	Compressor quantity	6	6	6	8
	Refrigerant type	R410A			
	Refrigerant charge (kg)	40.0	40.0	40.0	40.0
	Refrigerant liquid pipe (mm)	22.2	22.2	22.2	22.2
	Refrigerant gas pipe (mm)	44.5	44.5	44.5	44.5
	Refrigerant high gas pipe (mm)	41.3	41.3	41.3	41.3
	Max.total pipe length (m)	1000			
	Max. pipe length (Equivalent/Actual)	260/220			
	Max drop between I.U. & O.U. (O.U. down/up) *1 (m)	110/90			
	Standard drop between I.U. & O.U. (O.U. up/down) *2 (m)	50/40			
	Max drop between I.U. *3 (m)	30			
Standard drop between I.U. *4 (m)	18				
External static pressure (Pa)	110				
Connection ratio	Connectable indoor unit ratio (%)	50-130			
	Maximum number of indoor units	64	64	64	64
Working temp.	Cooling (°C)	-5-50			
	Heating (°C)	-23-21			

Max drop between I.U. & O.U *1 - If the height difference between the outdoor and the indoor units is from 50 to 110 m, contact your local distributor / dealer for individual design and production.

Standard drop between I.U. & O.U *2 - Standard design and production in the factory.

Max drop between I.U. *3 - If the height difference between the indoor units is from 18 to 30 m, contact your local distributor/dealer for individual design and production.

Standard drop between I.U. *4 - Standard design and production in the factory.

* All the specifications are tested under nominal condition (in cooling, indoor temp. is 27 °C DB / 19 °C WB; Outdoor temp. 35 °C DB / 24 °C WB; in heating, indoor temp. is 20 °C DB, in heating, outdoor temp. is 7 °C DB / 6 °C WB).

Model		VMV-R2280ARETA3	VMV-R2320ARETA3	VMV-R2360ARETA3	VMV-R2400ARETA3	
Combination model		VMV-R560ARETA3	VMV-R560ARETA3	VMV-R560ARETA3	VMV-R600ARETA3	
		VMV-R560ARETA3	VMV-R560ARETA3	VMV-R600ARETA3	VMV-R600ARETA3	
		VMV-R560ARETA3	VMV-R600ARETA3	VMV-R600ARETA3	VMV-R600ARETA3	
		VMV-R600ARETA3	VMV-R600ARETA3	VMV-R600ARETA3	VMV-R600ARETA3	
Capacity	Capacity range (HP)	82	84	86	88	
	Cooling (kW)	228.0	232.0	236.0	240.0	
	Heating (kW)	228.0	232.0	236.0	240.0	
	Heating - Max. (kW)	253.5	261.0	268.5	276.0	
Electrical parameters	Power supply (Ph/V/Hz)	3/380~415/50/60				
	Cooling	Rated power input (kW)	76.00	77.33	78.67	80.00
		Max power input (kW)	129.00	130.00	131.00	132.00
		Rated current (A)	125.51	127.72	129.92	132.12
		Max current (A)	213.04	214.70	216.35	218.00
	Heating	Rated power input (kW)	65.2	67.4	69.5	71.6
		Max power input (kW)	118.60	119.60	120.60	121.60
		Rated current (A)	107.7	111.2	114.8	118.3
		Max current (A)	195.87	197.52	199.17	200.82
	SEER	4.73	4.73	4.73	5.63	
	SCOP	3.5	3.5	3.5	3.5	
	ηs,c (%)	186	186	186	222	
	ηs,c (%)	137	137	137	137	
Performance	Air flow (m³ / h)	69000	70000	71000	72000	
	Sound pressure level (dB(A))	67	67	67	67	

3/380~415/50/60



Total pipe length 1000 m, height drop 110 m



Full DC inverter compressors



Single module 22HP, maximum combination 88HP



Automatic Oil balancing



VMV-R224ARETA3
VMV-R280ARETA3
VMV-R335ARETA3
VMV-R400ARETA3



VMV-R450ARETA3
VMV-R500ARETA3
VMV-R560ARETA3
VMV-R600ARETA3

Model		VMV-R2280ARETA3	VMV-R2320ARETA3	VMV-R2360ARETA3	VMV-R2400ARETA3
Installation	External dimensions - W/D/H (mm)	1410/750/1690 + 1410/750/1690 + 1410/750/1690 + 1410/750/1690			
	Shipping dimensions - W/D/H (mm)	1515/850/1858 + 1515/850/1858 + 1515/850/1858 + 1515/850/1858			
	Net/Shipping weight (kg)	1500/1616			
	Compressor type	DC INV. SCROLL			
	Compressor quantity	8	8	8	8
	Refrigerant type	R410A			
	Refrigerant charge (kg)	40.0	40.0	40.0	40.0
	Refrigerant liquid pipe (mm)	22.2	22.2	25.4	25.4
	Refrigerant gas pipe (mm)	44.5	44.5	50.8	50.8
	Refrigerant high gas pipe (mm)	41.3	41.3	44.5	44.5
	Max.total pipe length (m)	1000			
	Max. pipe length (Equivalent/Actual)	260/220			
	Max drop between I.U. & O.U. (O.U. down/up) *1 (m)	110/90			
	Standard drop between I.U. & O.U. (O.U. up/down) *2 (m)	50/40			
Max drop between I.U. *3 (m)	30				
Standard drop between I.U. *4 (m)	18				
External static pressure (Pa)	110				
Connection ratio	Connectable indoor unit ratio (%)	50-130			
	Maximum number of indoor units	64	64	64	64
Working temp.	Cooling (°C)	-5-50			
	Heating (°C)	-23-21			

Max drop between I.U. & O.U *1 - If the height difference between the outdoor and the indoor units is from 50 to 110 m, contact your local distributor / dealer for individual design and production.

Standard drop between I.U. & O.U *2 - Standard design and production in the factory.

Max drop between I.U. *3 - If the height difference between the indoor units is from 18 to 30 m, contact your local distributor/dealer for individual design and production.

Standard drop between I.U. *4 - Standard design and production in the factory.

* All the specifications are tested under nominal condition (in cooling, indoor temp. is 27 °C DB / 19 °C WB; Outdoor temp. 35 °C DB / 24 WB; in heating, indoor temp. is 20 °C DB, in heating, outdoor temp. is 7 °C DB / 6 °C WB).

VIVAX

DC INVERTER



Advanced
technology



High
efficiency



Super
comfort



Easy
installation



High
reliability

Advanced technology

Advanced sub-cooling technology (4,5,6 HP)

Two stage sub-cooling technology increases the efficiency by 9 %. Sub-cooling up to 30 °C increases the cooling capacity by 46 %.

Higher heating capacity

In low outdoor temperature conditions, system can achieve higher heating capacity thanks to enthalpy injection from the second stage sub-cooling.

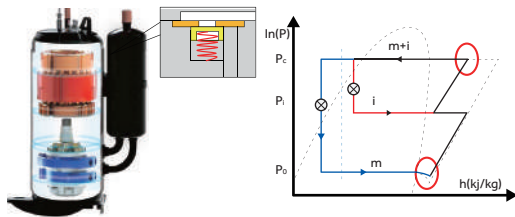

Upgraded configuration, upgraded performance (8 / 10 / 12 HP Side Discharge) Higher capacity, more flexible application



High efficiency DC fan motor
DC fan motor with stepless inverter control increases efficiency up to 45 % compared with AC fan motor.

Large diameter fan
Large diameter axial fan with a zig-zag design allows a higher air flow with a lower noise level.

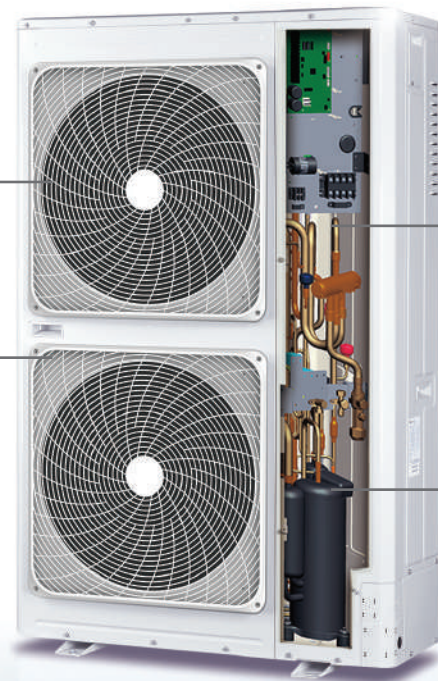

Double pressure sensors
High and low pressure sensors ensure real-time feedback regarding the suction and discharge pressure which enables quicker start of the compressor and the more accurate control.

Twin rotary DC inverter compressor
Twin rotary DC inverter compressor increases efficiency while reducing vibration and noise.

High efficiency

High energy efficiency (4 - 6 HP)

DC inverter compressor

- Power input lower by 5 % (5 HP)

550 mm fan with DC motor

- Power input lower by 38 % and air flow higher by 8 %.

Larger heat exchanger

- Heat exchange area increased by 10 %.

Charge valve

- Built-in charge valve enables safer and easier maintenance.

Low standby power

- New PCB program reduce the standby power consumption by 20 %.

DC inverter twin rotary compressor

DC inverter twin rotary compressor provides small torque changes and excellent dynamic balance which ensures stable operation with little vibration and low noise. It also allows higher efficiency, particularly when operating at partial load.

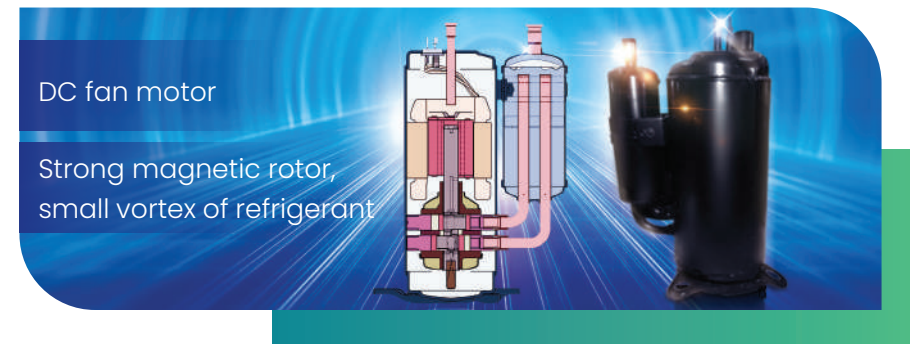

High comfort

Low noise operation

DC inverter compressor provides a smooth operation without frequent starting and stopping, ensuring the lower noise level. The unit also has a large diameter fan and a DC fan motor which also have a positive effects on lowering the noise level. Additionally it is possible to set a night mode function which reduces the noise up to 45 dB(A).

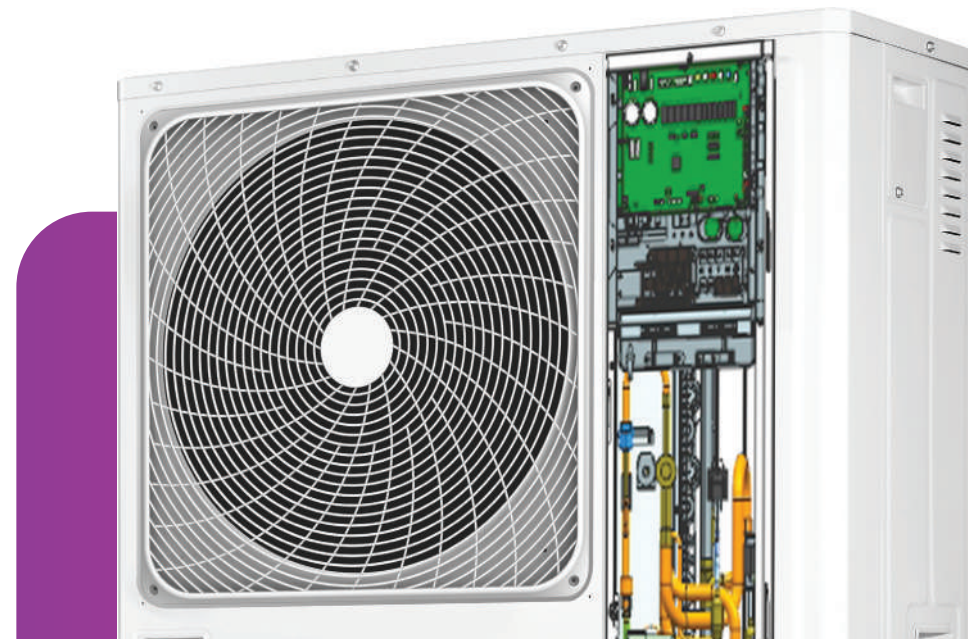
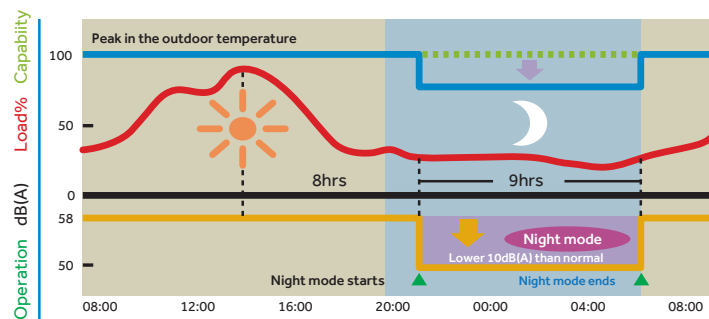

Easy installation

Double side "4" handles

Easy to carry

"888" test panel

All running data & error code can be checked from „888" screen, which is easy for installers.

"Four-way" pipe connection

4-way (front,back, left & right) pipe connection, easy to design and install.



Flexible long piping design

- 300 m maximum total piping length.
- 175 m maximum single piping length.
- 135 m maximum piping length between outdoor and the first branch.
- 40 m maximum piping length from the first branch to the farthest unit.
- 50 m / 40 m maximum height difference between ODU and IDU (ODU higher / IDU higher).
- 15 m maximum height difference between IDU and IDU.



Compact side discharge design

The unit covers an area of only 0,42 m² and there is no need for the additional air discharge hood as is the case with the top discharge units. Its design makes it suitable for installation at sites with limited installation space.



43 % floor area reduced

172 mm height reduced

Separate refrigerant charging valve

The unit is equipped with the separate refrigerant charging valve which enables easier and safer maintenance.



Parameter display panel

The parameter display is located on the side of the unit. Parameters can be read directly by opening the display cover without the need to dismantle the chassis of the unit.

Parameter display

Cover



High reliability

Automatic refrigerant recovery technology

Automatic refrigerant recovery can be set through dip switches on the outdoor units PCB. When activated this function recovers the refrigerant in the pipeline and indoor units and returns it to the outdoor unit which is reducing maintenance time and cost.

Refrigerant control technology

Refrigerant control technology without the high pressure accumulator increases the system efficiency and reduces the refrigerant volume.

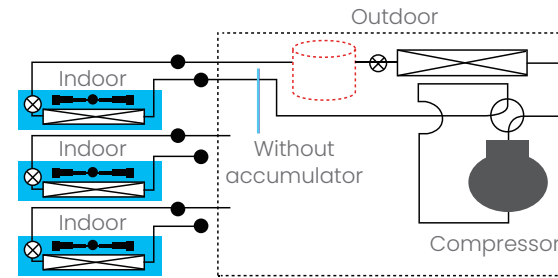

Air inlet grille design

Air inlet grille is located on the top right side of the chassis of outdoor unit. Its design allows easy entrance of air for cooling the control module while keeping the dust out of the unit.

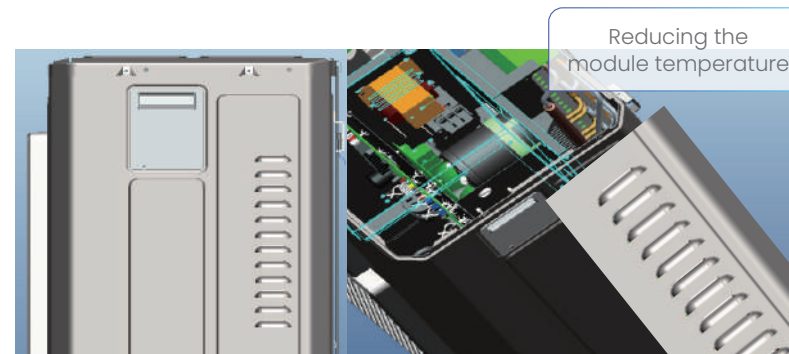

Double pressure sensors

High and low pressure sensors ensure real-time feedback regarding the suction and discharge pressure which enables quicker start of the compressor and the more accurate control.

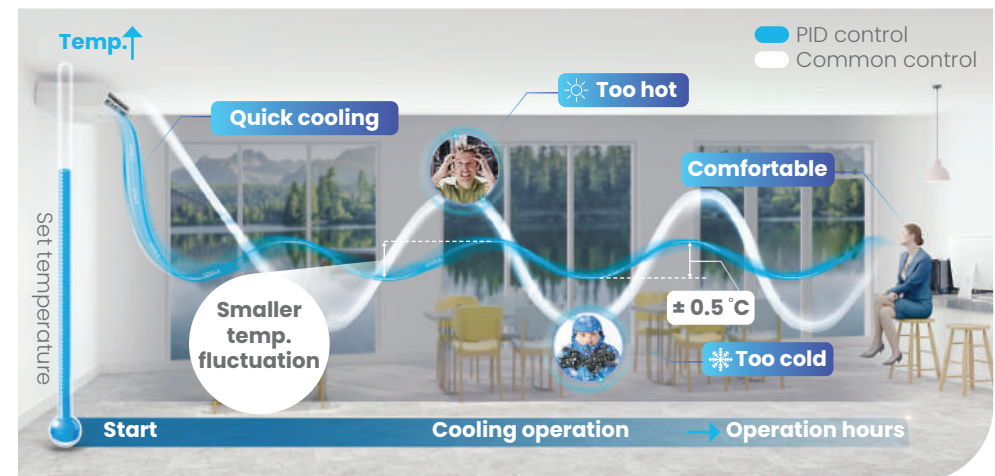

Model		VMV-S121AREHSA1	VMV-S140AREHSA1
Capacity	Capacity range (HP)	4	5
	Cooling (kW)	12,1	14
	Heating (kW)	12,1	14
	Heating - Max (Kw)	14	15,5
	SEER (TI)	4,9	4,85
	ηs,c (%)	193	191
	SCOP (TI)	3,5	3,55
	ηs,c (%)	137	139
Electrical parameters	Power supply (Ph/v/Hz)	1/220-240/50/60	
	Rated power input - Cooling (kW)	4.25	5.00
	Rated power input - Heating (kW)	4.10	4.83
Dimensions	External - W/D/H (mm)	950/370/965	
	Shipping - W/D/H (mm)	1010/458/990	
Weight	Net/Shipping weight (kg)	90/102	
Compressor	Compressor type	Rotary	
	Motor power (W)	4130	
	Compressor quantity	1	
Fan	Air flow - H (m³/h)	5400	
Pressure sound level	Cooling (dB(A))	58	60
	Heating (dB(A))	60	62
Refrigerant	Type	R410A	
	Charge (kg)	3.3	
Piping	Refrigerant liquid pipe (mm)	9.52	
	Refrigerant gas pipe (mm)	15.88	
	Total pipe length (m)	120	
	Max. pipe length (Equivalent/Actual)	70/60	
	Max drop between I.U. & O.U. (ODU above/below) (m)	30/20	
	Max drop between I.U. & I.U. (m)	10	
Connection ratio	Connectable indoor unit ratio (%)	50-130	
	Maximum number of indoor units	7	8
Working temp.	Cooling (°C)	-5-50	
	Heating (°C)	-15-21	



VMV-S121AREHSA1
VMV-S140AREHSA1

(1) All the specifications are tested under nominal condition (In cooling, Indoor temp is 27 °C DB / 19 °C WB; Outdoor temp 35 °C DB / 24 °C WB; In heating, Indoor temp is 20 °C DB, Outdoor temp is 7 °C DB / 6 °C WB)

Model		VMV-S121AREHDA1	VMV-S140AREHDA1	VMV-S155AREHDA1	VMV-S121AREHDA3	VMV-S140AREHDA3	VMV-S155AREHDA3	
Capacity	Capacity range (HP)	4	5	6	4	5	6	
	Cooling (kW)	12.1	14	15.5	12.1	14	15.5	
	Heating (kW)	12.1	14	15.5	12.1	14	15.5	
	Heating - Max. (kW)	14.2	16	18	14.2	16	18	
	SEER (TI)	6.82	6.65	6.80	6.82	6.65	6.80	
	η _{s,c} (%)	270	263	269	270	263	269	
	SCOP (TI)	4.05	4.11	4.05	4.05	4.11	4.05	
	η _{s,c} (%)	159	161	159	159	161	159	
Electrical parameters	Power supply (Ph/v/Hz)	1/220-240/50/60						
	Rated power input - Cooling (kW)	3.61	4.33	5.17	3.61	4.33	5.17	
	Rated power input - Heating (kW)	3.23	3.76	5.00	3.23	3.76	5.00	
Dimensions	External - W/D/H (mm)	950/370/1350						
	Shipping - W/D/H (mm)	1023/471/1420						
Weight	Net/Shipping weight (kg)	108/123						
Compressor	Compressor type	Rotary						
	Motor power (W)	4130			4060			
	Compressor quantity	1						
Fan	Air flow - H (m ³ /h)	7200						
Pressure sound level	Cooling (dB(A))	57	58	59	57	58	59	
	Heating (dB(A))	57	58	59	57	58	59	
Refrigerant	Type	R410A						
	Charge (kg)	4						
Piping	Refrigerant liquid pipe (mm)	9.52						
	Refrigerant gas pipe (mm)	15.88						
	Total pipe length (m)	300						
	Max. pipe length (Equivalent/Actual)	175/150						
	Max drop between IDU & ODU (m)	50						
	Max drop between IDU & IDU (m)	15						
Connection ratio	Connectable indoor unit ratio (%)	50-130						
	Maximum number of indoor units	8	10	13	8	10	13	
Working temp.	Cooling (°C)	-5-50						
	Heating (°C)	-20-27						

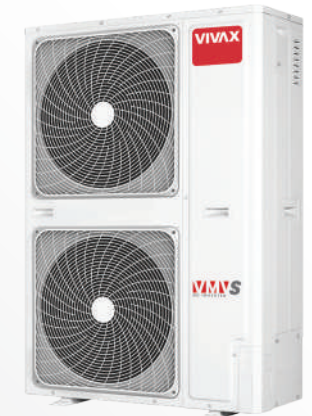

VMV-S121AREHDA1
VMV-S140AREHDA1
VMV-S155AREHDA1
VMV-S121AREHDA3
VMV-S140AREHDA3
VMV-S155AREHDA3



Double fan series



Total pipe length 300 m



Two stage sub-cooling



Easy connection with 4 way

(1) All the specifications are tested under nominal condition (In cooling, Indoor temp is 27 °C DB / 19 °C WB; Outdoor temp 35 °C DB / 24 °C WB; In heating, Indoor temp is 20 °C DB, Outdoor temp is 7 °C DB / 6 °C WB)

Model		VMV-S226AREHDA3	VMV-S280AREHDA3	VMV-S315AREHDA3
Capacity	Capacity range (HP)	8	10	12
	Cooling (kW)	22.6	28	31.5
	Heating (kW)	22.6	30.5	31.5
	Heating - Max (Kw)	25	32	35
	SEER (TI)	7.67	7.65	7.47
	$\eta_{s,c}$ (%)	304	303	296
	SCOP (TI)	4.05	4.16	4.21
	$\eta_{s,c}$ (%)	159	163.4	165.4
Electrical parameters	Power supply (Ph/v/Hz)	3/380~415/50/60		
	Rated power input - Cooling (kW)	6.95	8.67	11.52
	Rated power input - Heating (kW)	5.79	8.03	8.49
Dimensions	External - W/D/H (mm)	1050/400/1636		
	Shipping - W/D/H (mm)	1150/510/1790		
Weight	Net/Shipping weight (kg)	149/168		
Compressor	Compressor type	Inverter Twin Rotary		
	Motor power (W)	6270		
	Compressor quantity	1		
Fan	Air flow - H (m ³ /h)	10000		
Pressure sound level	Cooling (dB(A))	63	64	65
	Heating (dB(A))	65	66	67
Refrigerant	Type	R410A		
	Charge (kg)	5.1		
Piping	Refrigerant liquid pipe (mm)	9.52		12.7
	Refrigerant gas pipe (mm)	19.05	22.22	25.4
	Total pipe length (m)	300		
	Max. pipe length (Equivalent/Actual)	175/150		
	Max drop between I.U. & O.U. (ODU above/below) (m)	50		
	Max drop between I.U. & I.U. (m)	15		
Connection ratio	Connectable indoor unit ratio (%)	50-130		
	Maximum number of indoor units	13	16	19
Working temp.	Cooling (°C)	-5-48		
	Heating (°C)	-20-27		



VMV-S226AREHDA3
VMV-S280AREHDA3
VMV-S315AREHDA3

(1) All the specifications are tested under nominal condition (In cooling, Indoor temp is 27 °C DB / 19 °C WB; Outdoor temp 35 °C DB / 24 °C WB; In heating, Indoor temp is 20 °C DB, Outdoor temp is 7 °C DB / 6 °C WB).

Dimensions

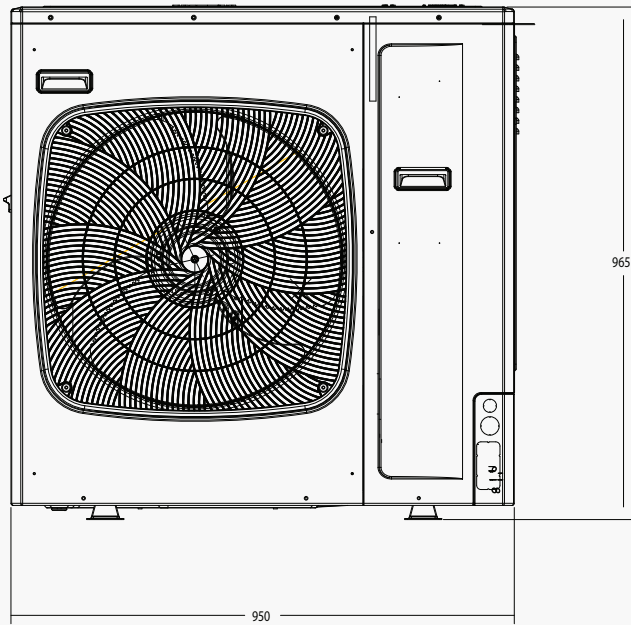

VMV-S121AREHSA1, VMV-S140AREHSA1

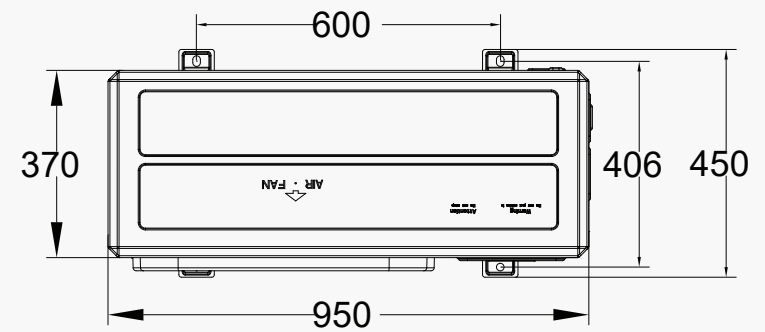
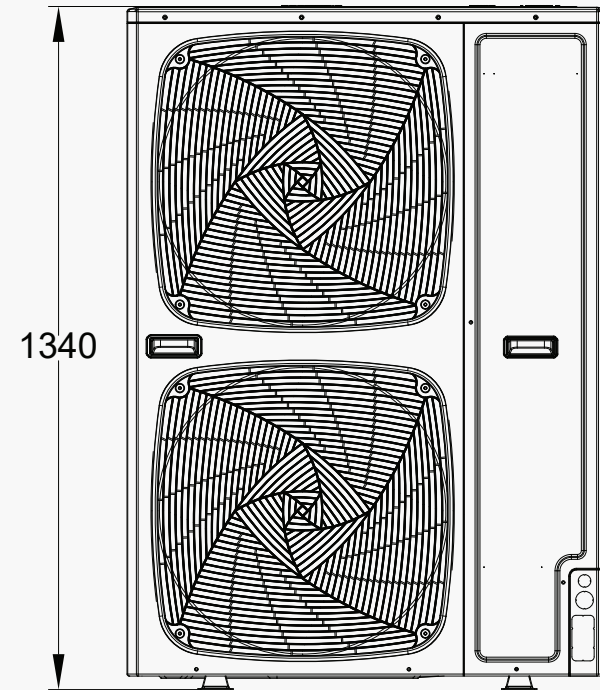
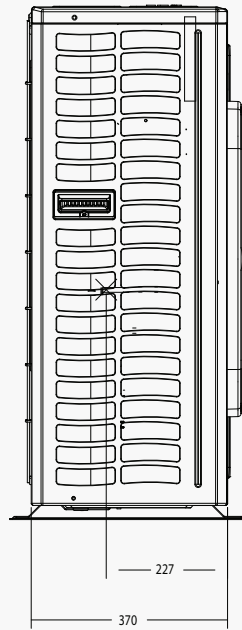

**VMV-S121AREHDA1, VMV-S140AREHDA1, VMV-S155AREHDA1,
VMV-S121AREHDA3, VMV-S140AREHDA3, VMV-S155AREHDA3**

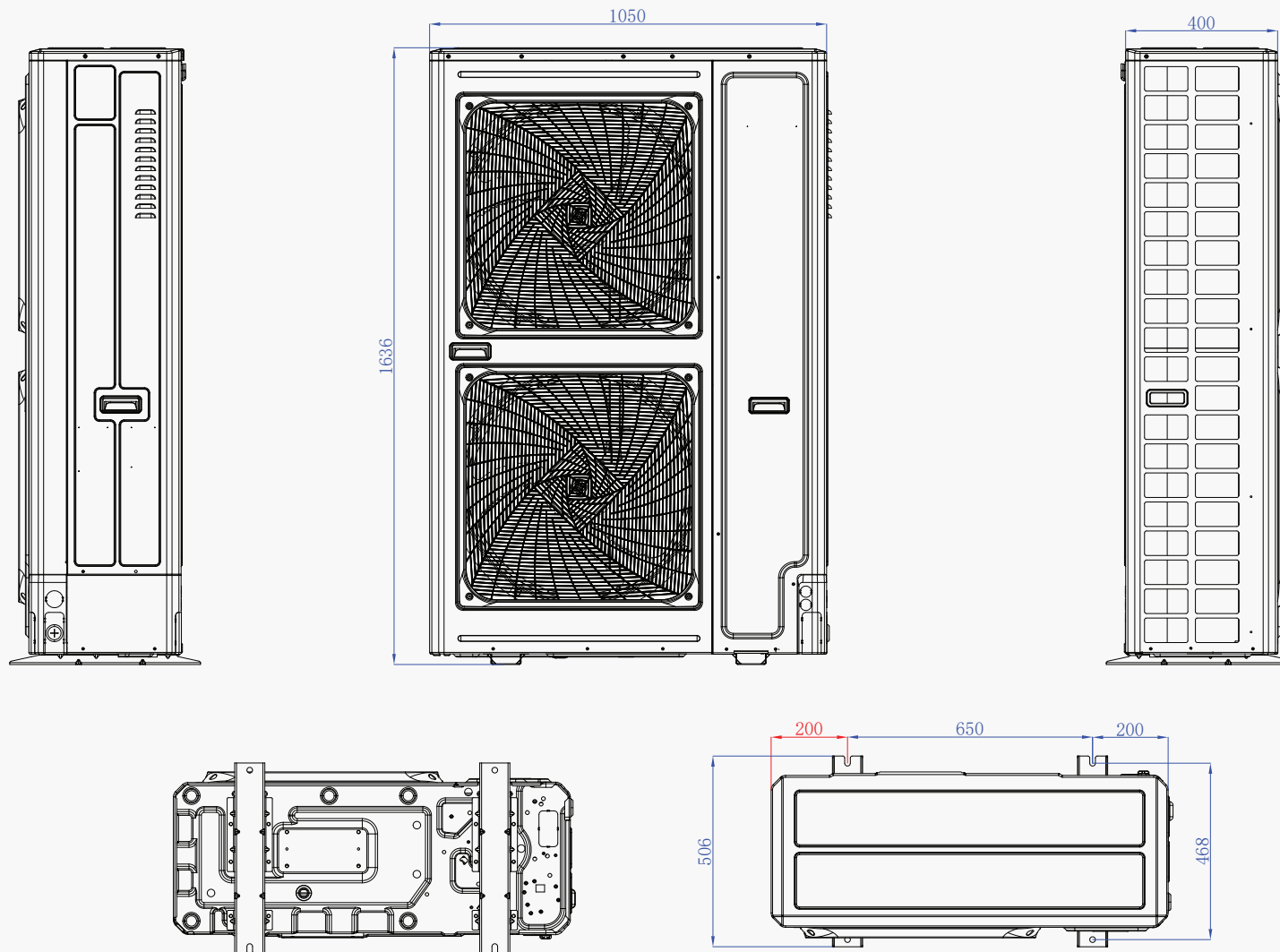

VMV-S226AREHDA3, VMV-S280AREHDA3, VMV-S315AREHDA3

AHU KIT



System introduction

System introduction

VMV AHU kit provides heating and cooling solutions for the third-party air handling units equipped with a DX heat exchanger.

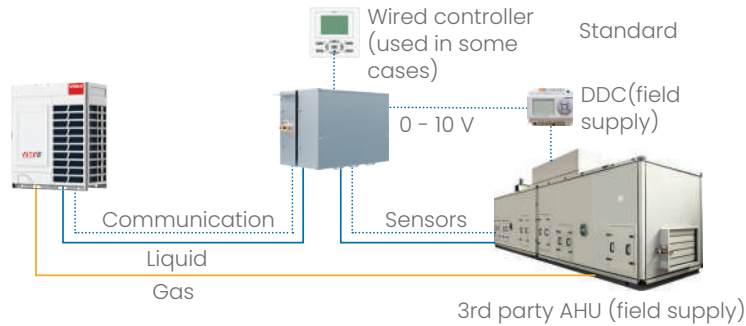

Ahu kit configuration

AHU kit consists of electric expansion valve, control box, temperature sensors and a wired controller.

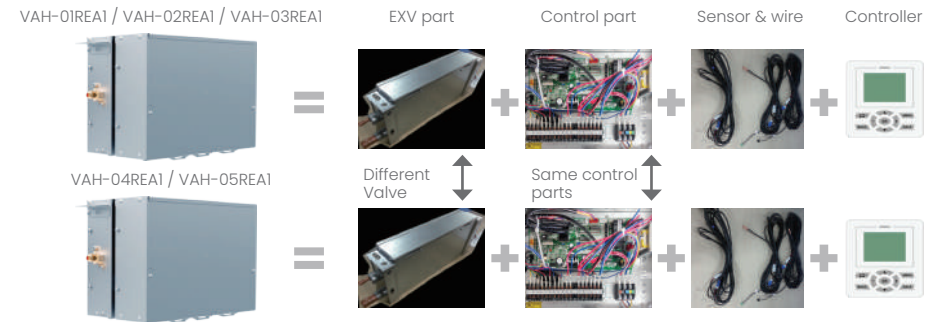

System line-up

AHU kit provides a wide range of capacity solutions of the connected air handling units and could be used as a separate solution, or could be installed together with other Vivax VRF indoor units.

DX AHU ² Connection kit					Special design for VMV 5, VMV S
Model	VAH-01REA1	VAH-02REA1	VAH-03REA1	VAH-04REA1	VAH-05REA1
Capacity	3.5 ≤ Connected AHU capacity ≤ 7kW	7 < Connected AHU capacity ≤ 14kW	14 < Connected AHU capacity ≤ 28kW	28 < Connected AHU capacity ≤ 56kW	56 < Connected AHU capacity ≤ 73kW
VMV series	VMV 5, VMV S (4 / 5 / 6 / 8 / 10 / 12 HP Double fan)				
Compatibility					
Outdoor	VMV 5			VMV S	
Capacity					
HP	8 - 26			4, 5, 6	8, 10, 12
Power supply	3 Ph / 380 - 415 V / 50 / 60 Hz			1 Ph / 220 - 230 V / 50 / 60 HZ 3 Ph / 380 - 400 V / 50 / 60 Hz	3 Ph / 380 - 400 V / 50 / 60 Hz
AHU & VMV indoor					

Control solutions

AHU kit has a possibility of using four different control methods which allows flexibility and possibility to integrate in various systems.

Control method A

- 0 - 10 V signal output from DDC
- AHU kit receives 0 - 10 V signal to adjust the ODU capacity

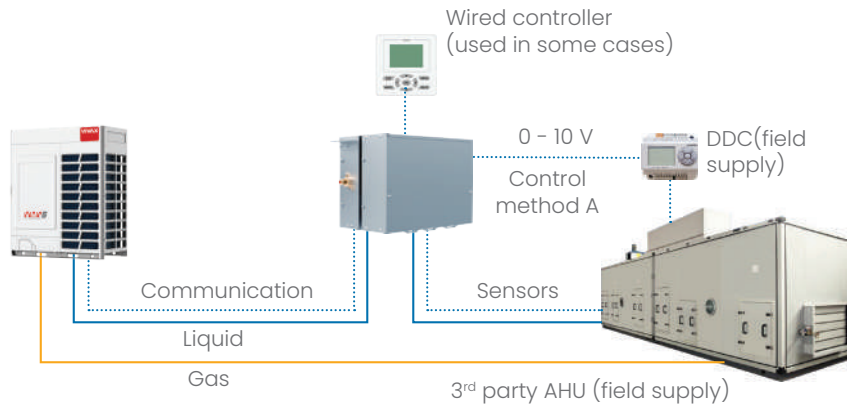

Control method B

- Control temperature via DDC
- 0-10 V signal output from DDC
- AHU kit receives 0-10 V signal to adjust set-point temperature

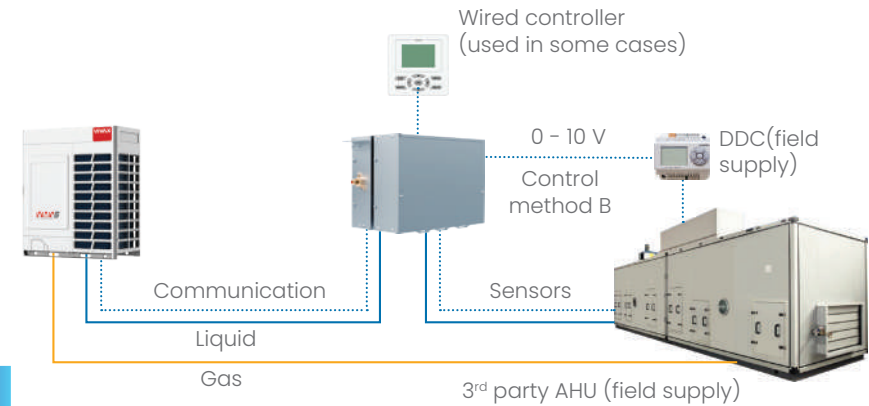

A B
C D

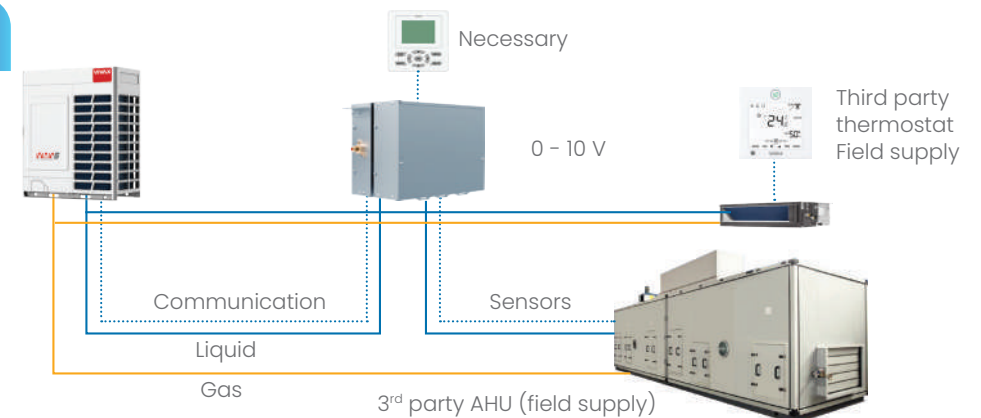
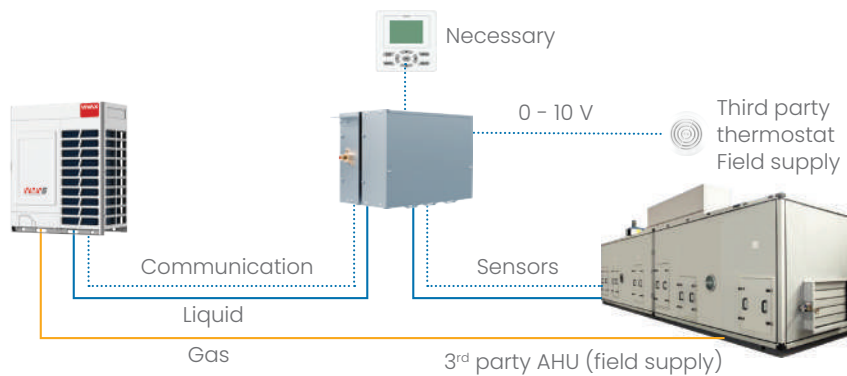

Control method C (Special application)

- Without DDC
- VIVAX wired controller is necessary for initial set-up but not required for operation
- Third party thermostat provides ON/Off signal to AHU kit when the set point temperature reaches
- Applicable for some cases with constant cooling or heating demand and sensitive comfort demands

Control method D

- Similar to original AHU kit V 1.0
- Control AHU as VRF indoor units
- Return / Room temperature control
- VIVAX wired controller is used to operate
- Control method for combination VRF indoor units and 3rd party AHU system

Central control and BMS

AHU kit can be connected to a central controller and the BMS system. For the control methods A, B, and C only monitoring function is available, while the control method D allows both monitoring and control of the AHU system.

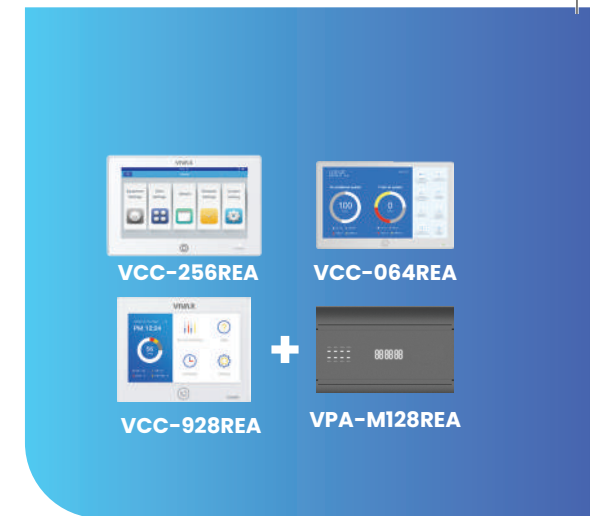

Unit structure

Features

Available capacities of connected AHU are in range between 3,5 kW and 73 kW when connected with a single AHU kit. When connected with a combination of more AHU kits the AHU capacity can be up to 292 kW. System could receive a 0-10 V control signal input. Only liquid pipe connection.

VMV AHU Combination method

Capacity	Combination model
$3 \leq x \leq 7$ kW	VAH-01REA1
$7 < x \leq 14$ kW	VAH-02REA1
$14 < x \leq 28$ kW	VAH-03REA1
$28 < x \leq 56$ kW	VAH-04REA1
$56 < x \leq 73$ kW	VAH-05REA1
$73 < x \leq 112$ kW	VAH-04REA1 + VAH-04REA1
$112 < x \leq 146$ kW	VAH-05REA1 + VAH-05REA1
$146 < x \leq 168$ kW	VAH-04REA1 + VAH-04REA1 + VAH-04REA1
$168 < x \leq 219$ kW	VAH-05REA1 + VAH-05REA1 + VAH-05REA1
$219 < x \leq 224$ kW	VAH-04REA1 + VAH-04REA1 + VAH-04REA1 + VAH-04REA1
$224 < x \leq 292$ kW	VAH-05REA1 + VAH-05REA1 + VAH-05REA1 + VAH-05REA1

Note:
The above is the combination method for single heat exchanger, when multiple heat exchangers need to be matched according to the capacity of each heat exchanger

VMV AHU Connection Kit

Model	VAH-01REA1	VAH-02REA1	VAH-03REA1	VAH-04REA1	VAH-05REA1
Connected (kW)	3.5 < X ≤ 7	7 < X ≤ 14	14 < X ≤ 28	28 < X ≤ 56	56 < X ≤ 73
AHU capacity	(1-3 HP)	(3-5 HP)	(5-10 HP)	(10-20 HP)	(20-26 HP)
Power Supply (Ph/V/Hz)	1/220-240/50/60				
Dimension - W/D/H (mm)	420/260/165	420/260/165	420/260/165	420/260/215	420/260/215
Shipping dimensions - W/D/H (mm)	520/340/225	520/340/225	520/340/225	520/340/275	520/340/275
Material	Galvanized steel	Galvanized steel	Galvanized steel	Galvanized steel	Galvanized steel
Color	Grey	Grey	Grey	Grey	Grey
Weight (kg)	5.5	5.5	5.5	6.5	6.5
Shipping Weight (kg)	8.5	8.5	8.5	10	10
Liquid pipe (mm)	9.52 (Main) / 6.35	9.52 (Main) / 6.35	9.52 (Main) / 6.35	12.7 (Main) / 15.88	12.7 (Main) / 15.88
AHU Kit-3rd party AHU Max Single pipe length (m)	5	5	5	5	5
AHU Kit-3rd party AHU Max Single pipe length (m)	5	5	5	5	5



Dimensions

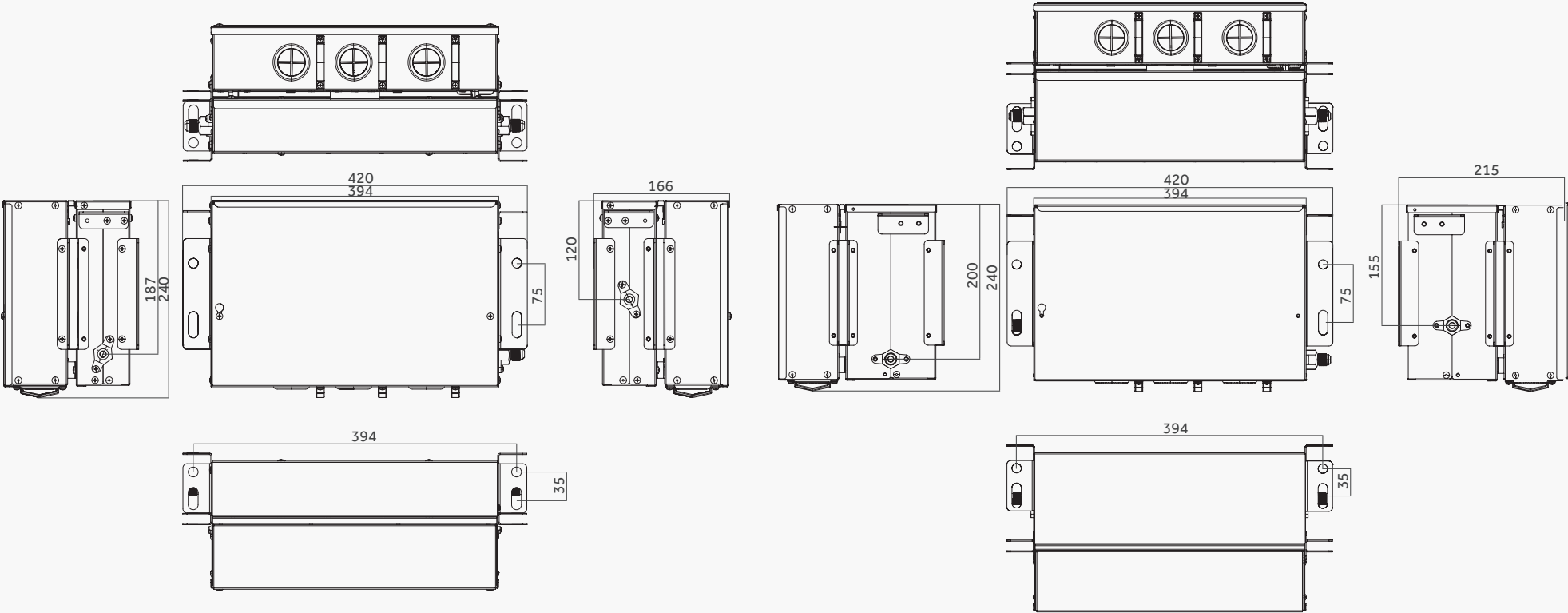

VAH-01REA1, VAH-02REA1, VAH-03REA1

VAH-04REA1, VAH-05REA1

VMV Indoor Units



Cassette



Convertible



Duct



Built-in floor
standing



Console



High wall

1-Way Cassette



Suitable for corner installation for comfortable and uniform air supply

Compact design, full use of corner space installation, such as small meeting rooms, corridors etc.; The indoor unit is built in the ceiling. Suitable for long and narrow rooms, to ensure the uniform distribution of air flow and room temperature.



High comfort with wide angle air supply

The unit has high efficient DC fan motor and is equipped with a horizontal and vertical swing motor which allows a wide angle of supply air direction, hence improving the indoor comfort.



Built-in drain pump

Unit is equipped with drain pump with built-in float switch, and is capable to deliver the water 700 mm high.

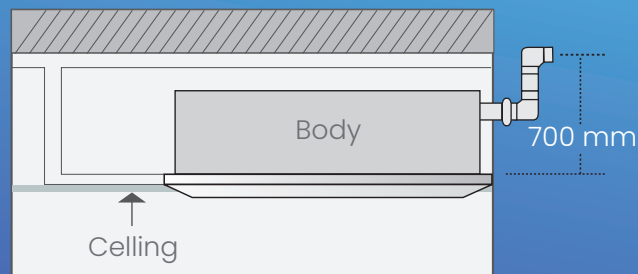

2-Way Cassette

Easy installation

Height of only 220 mm and low weight of the unit provides easy installation in locations with limited installation space.

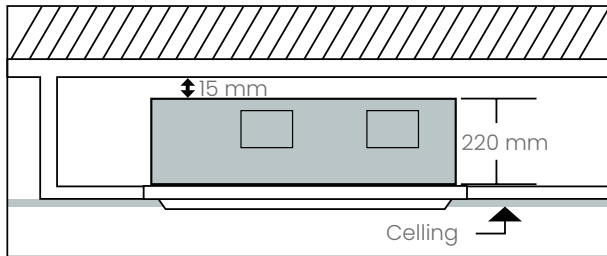

Built-in drain pump

Unit is equipped with drain pump with built-in float switch, and is capable to deliver the water 750 mm high.

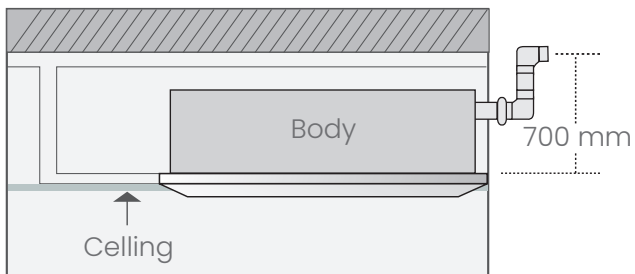

Special design for preventing fouling on the ceiling

The unit has special design of the air outlet louver which redirects the cold air to not flow near the ceiling and prevents the fouling.



Round Way Cassette

Flexible air outlet in all directions

Unit has four air outlet louvers with 6 adjustable positions and it is possible to independently control each. Unit has round-way air outlet with no blind spot.



Built-in drain pump

Unit is equipped with drain pump with built-in float switch, and is capable to deliver the water 700 mm high.

Hidden display and self diagnostic

Unit has a hidden display on the panel which can show an error codes for easier maintenance.

Slim design

Units height of only 183 makes it perfect for installation on places with limited installation space.



Low noise and energy efficient operation

Units are equipped with a DC fan motor, a fan with a aerodynamic design and a large air inlet grille which reduce noise level and improves the energy efficiency.



Compact Four Way Cassette

Compact design

VIVAX Compact Four Way Cassette has dimensions of 570 x 570 mm, which makes it ideal for easy installation in existing dropped ceiling.



Built-in drain pump

Unit is equipped with drain pump with built-in float switch, and is capable to deliver the water 700 mm high.

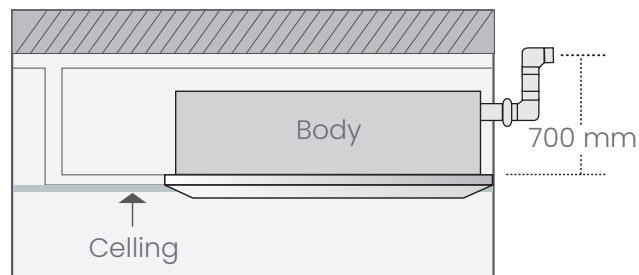

Low noise and energy efficient operation

Units are equipped with a DC fan motor, a fan with a aerodynamic design and a large air inlet grille which reduce noise level and improves the energy efficiency.



Flexible air outlet in all directions

Unit has four air outlet louvers with 6 adjustable positions and it is possible to independently control each.

Fresh air inlet

The unit is equipped with fresh air inlet which can improve indoor air quality.

Floor – Ceiling

Air filtration

The unit is equipped with a high efficiency air filter which removes dust and improves the air quality. Filter can be easily removed which simplifies the maintenance.

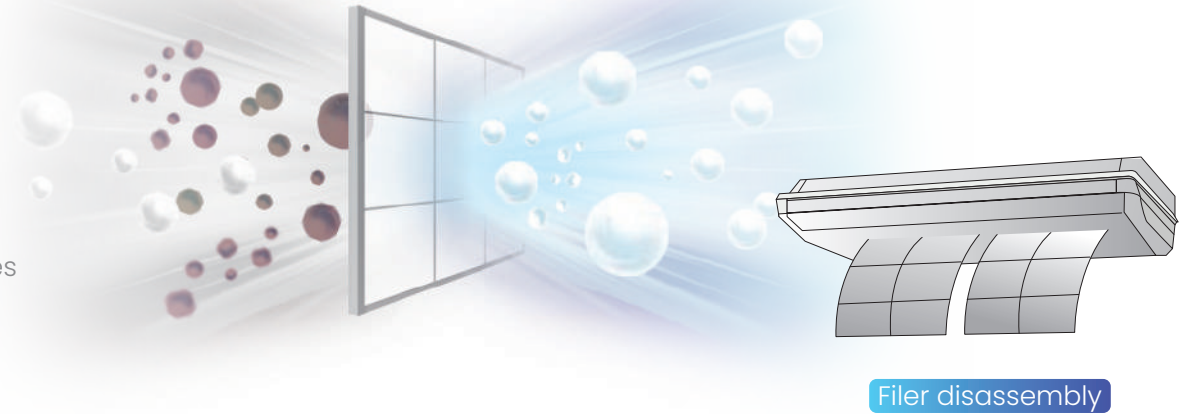

Flexible air distribution

Unit has a horizontal and vertical automatic, five step, swing control which allows flexible air distribution.

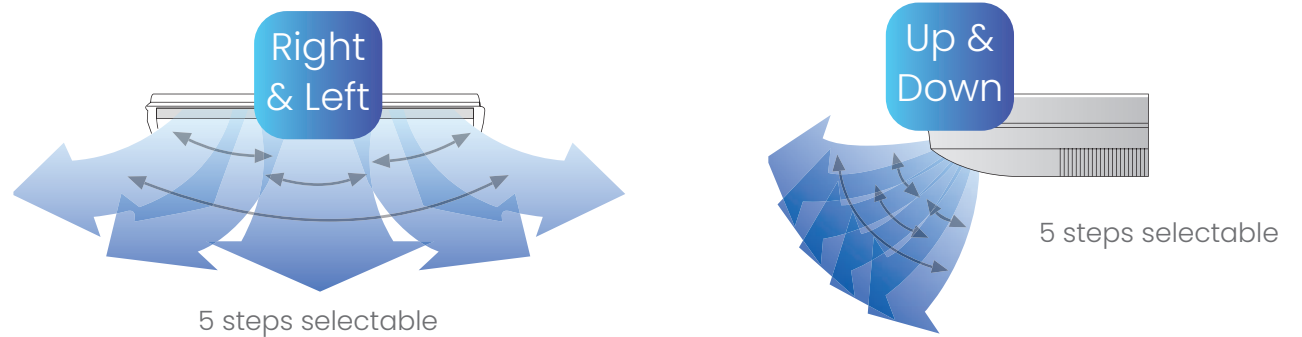

Flexible installation

Unit could be installed either on the floor or in the ceiling.

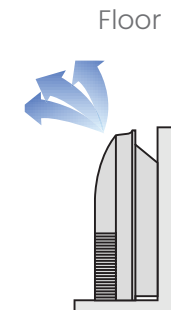
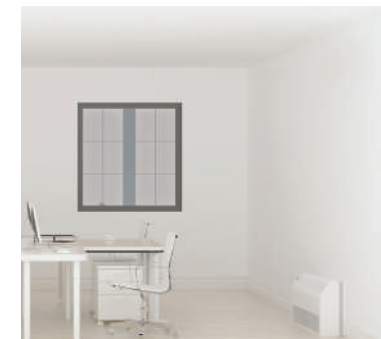
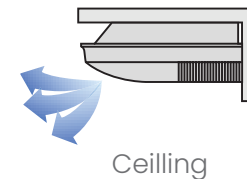
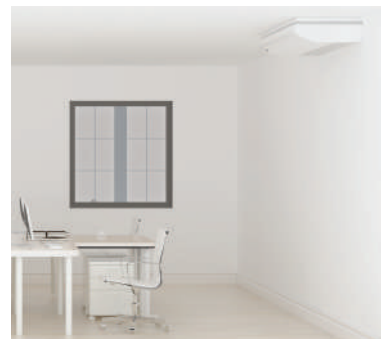

Slim Duct

Slim design

Height of only 185 mm allows the installation in the locations with a limited available ceiling height.

Built-in drain pump

Unit is equipped with drain pump with built-in float switch, and is capable to deliver the water 700 mm high.

Low noise operation

DC fan motor and air inlet and outlet design contributes to the lower noise level during operation.

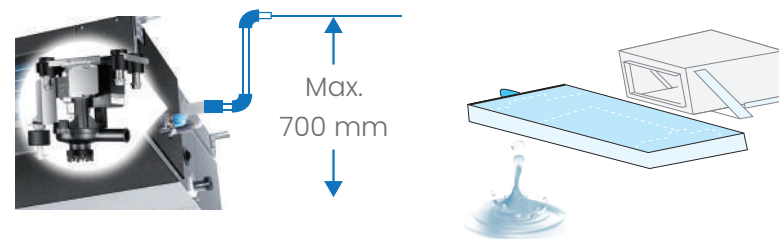

Flexible return air installation

Unit has a air return connection from the rear side, but when there is a lack of the installation space air return could also be connected from the bottom.

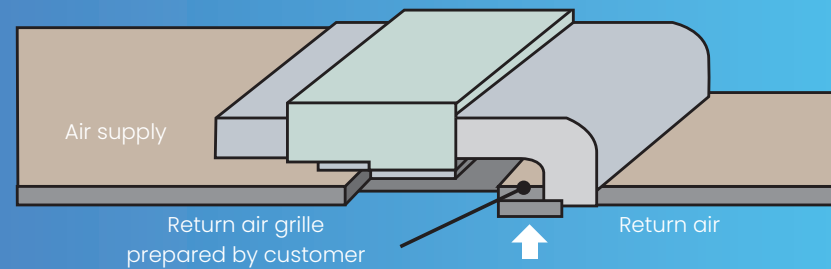

Air return mode from rear (factory standard air return mode)

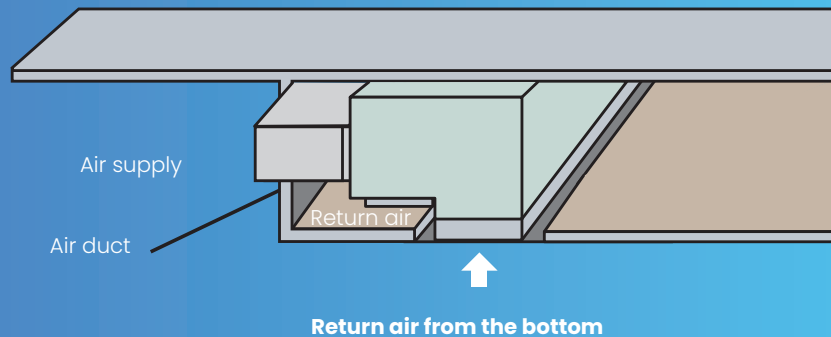

High quality material

Air intake and outlet panel is made from high quality plastic material (PC-ABS) which has high heat, impact and deformation resistance.

Hidden display

The outlet air panel has a hidden display which shows temperature, and has a red color while operating in heating mode and green color in the cooling mode.

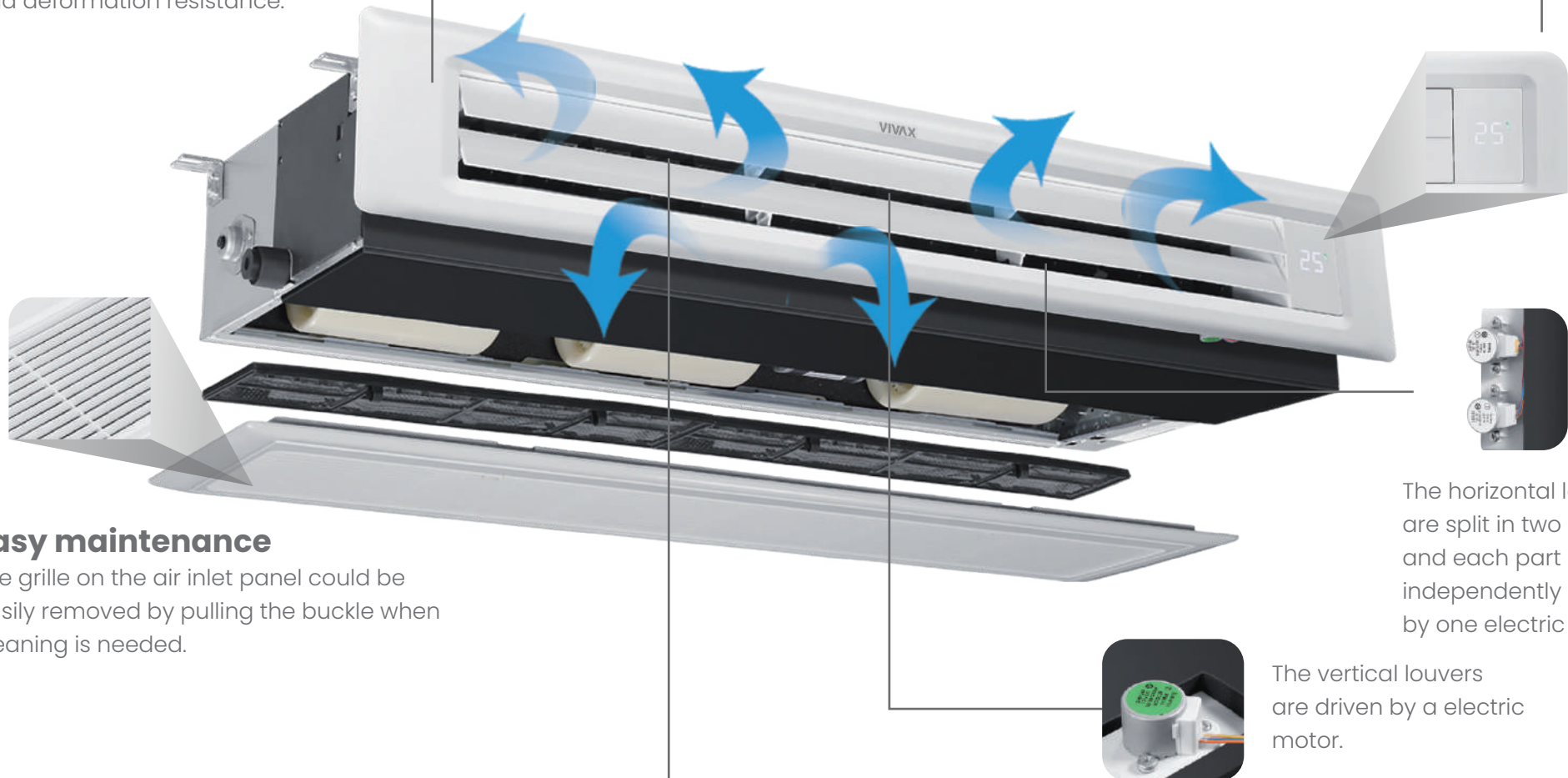

Easy maintenance

The grille on the air inlet panel could be easily removed by pulling the buckle when cleaning is needed.

3D air supply

Louvers in the outlet air panel could be controlled in vertical and horizontal directions providing a comfortable air supply.

The horizontal louvers are split in two parts and each part is independently driven by one electric motor.

The vertical louvers are driven by a electric motor.

High ESP Duct

Variable duct connection

High available static pressure allows connection on the multiple ducts.

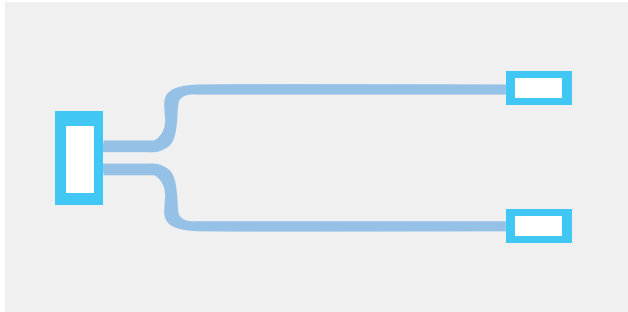

The long room

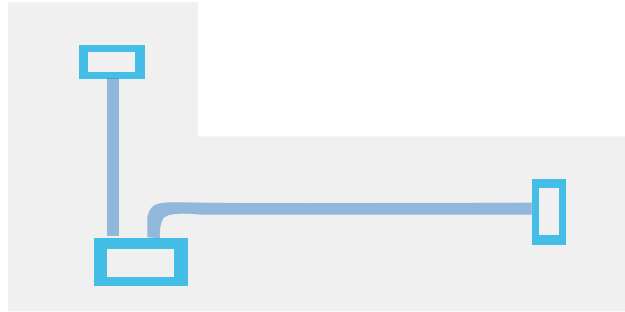

L room

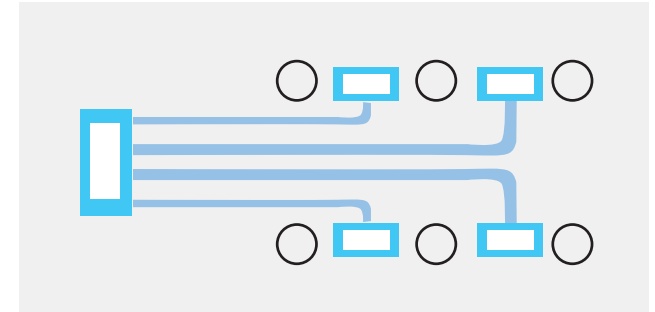

A room with ceiling fixtures

Low noise design

Combination of the DC fan motor, 5 available fan speed and sound insulation allows operation at a low noise level.

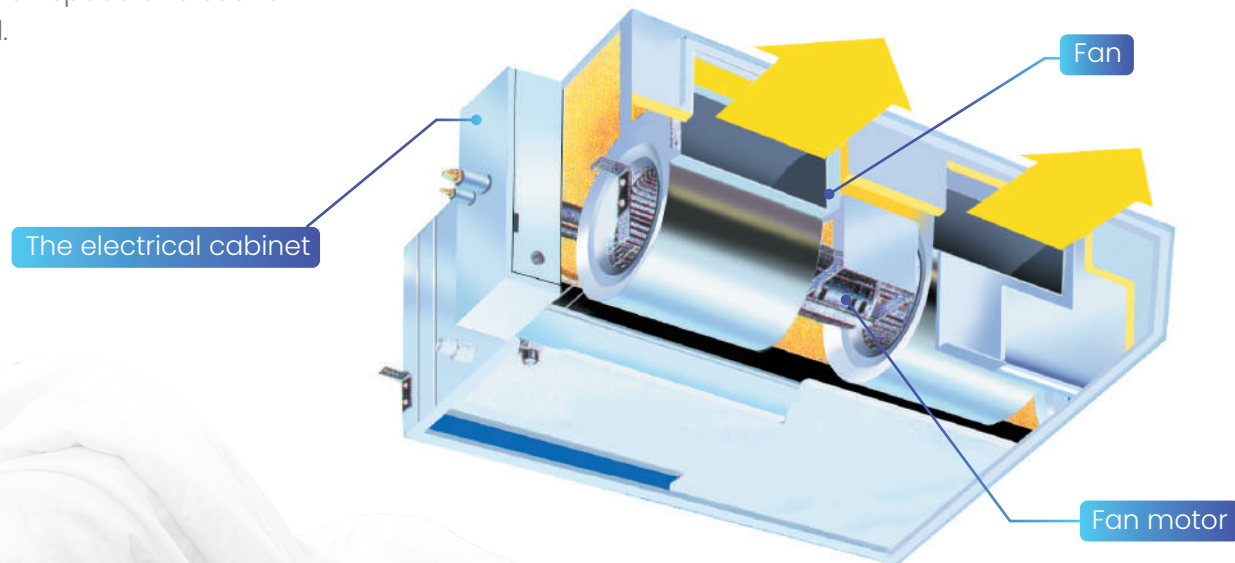

Built in floor standing

Slim design for concealed installations

Thanks to its slim design and depth of only 221 mm, the VIVAX Built in floor standing unit can be easily installed in decorative housings.



Available static pressure of 30 Pa

Built in floor standing units are equipped with a fan that ensures a static pressure of up to 30 Pa. This allows unit to be installed inside decorative housings.

Console

Double air exhaust

Console units have air exhaust on two sides for even more efficient heating and cooling. Deflectors intelligently direct cold air up and hot air down, to set the perfect temperature quickly and efficiently without blowing air directly at the people in the room.

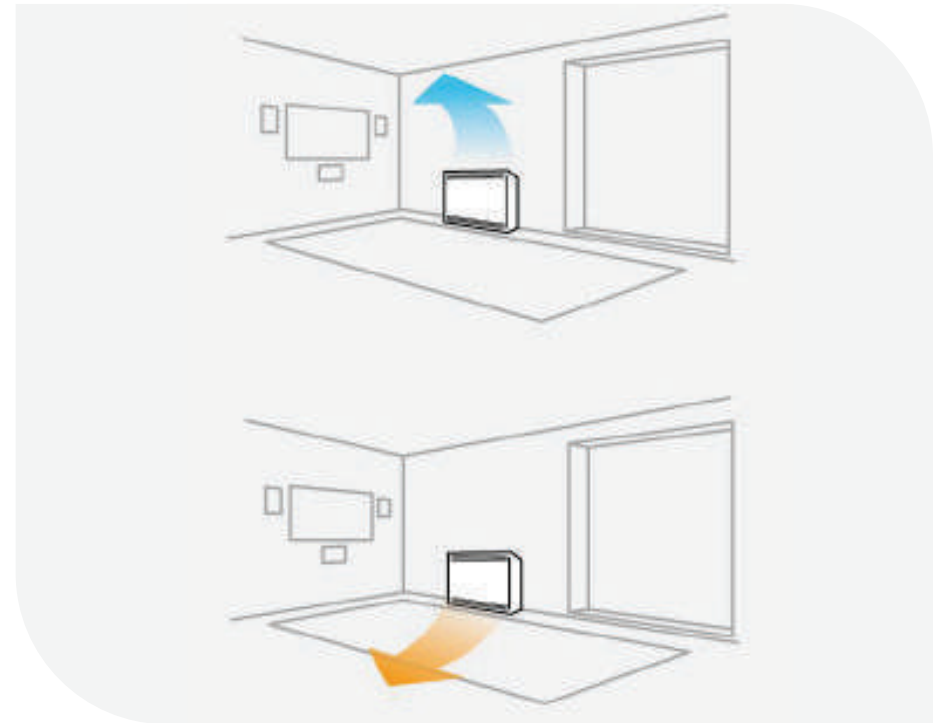

Compact design

Console units have compact design which allows easy installation on the floor or against the wall even if the available installation space is limited.

High Wall

Built-in electronic expansion valve

The unit has a built-in electronic expansion valve which allows a simpler installation. (version with external expansion valve is also available).

Electronic expansion valve built in

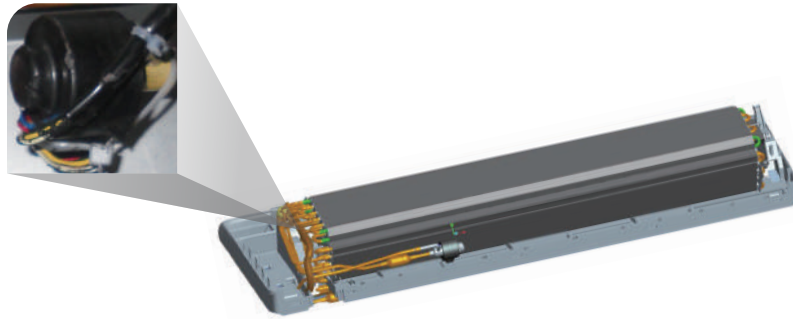

Flexible air supply control

DC fan motor, and multiple available louver positions allows flexible air supply control. When working in cooling mode air supply is automatically directed up, and during operation in heating mode air is blown down to ensure maximum comfort

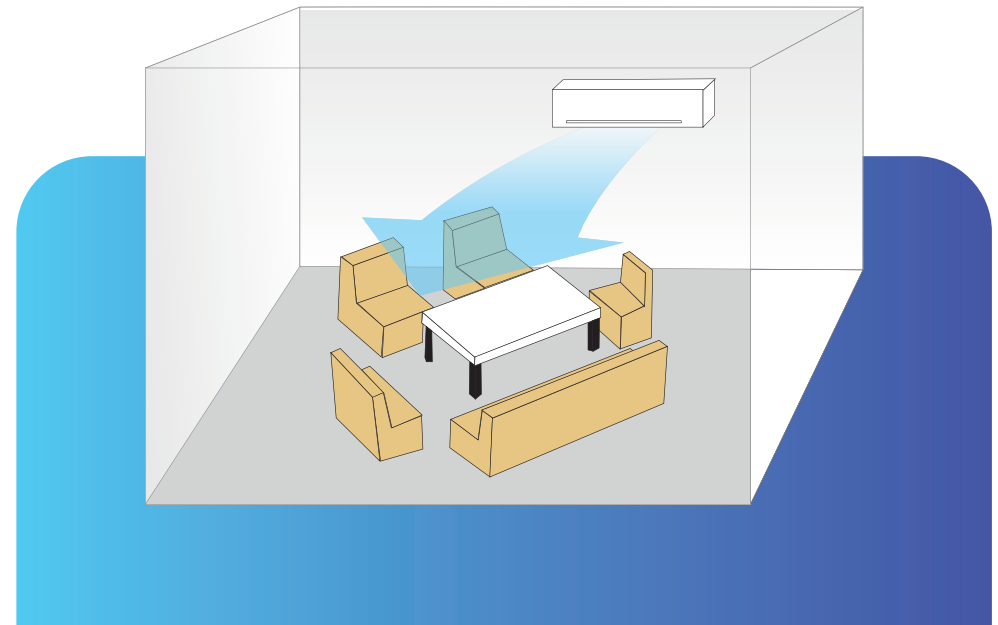
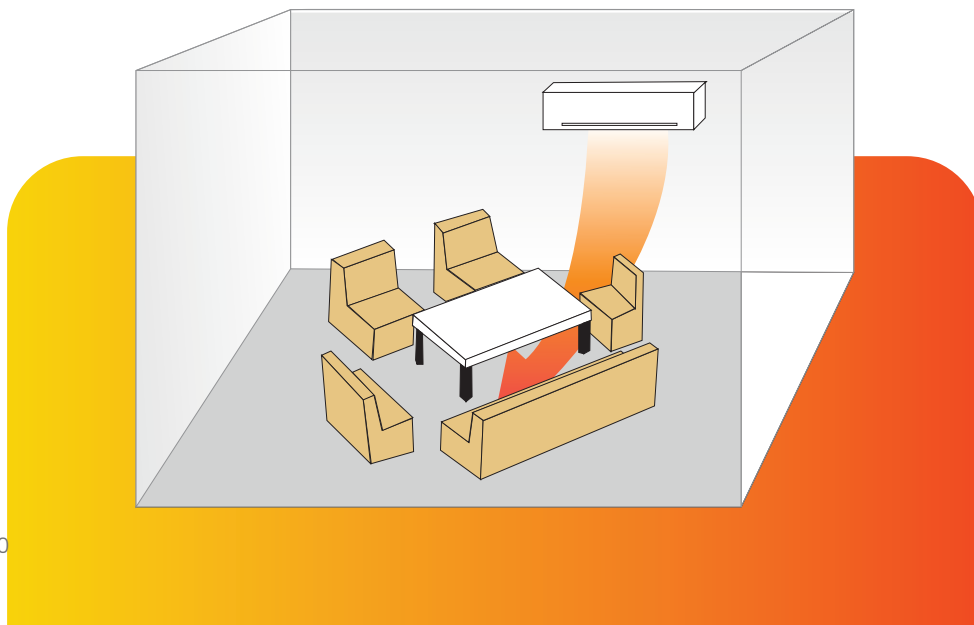

Hydro box

Ultimate comfort

The hydro unit has a heating capacity of up to 28 kW per module which can be used in combination for bigger system demand. Water temperature range is from 5 °C to 50 °C and provides comfort to users.

Low operating cost

By using free renewable energy from the outside air as heat source, it is more energy efficient than oil and gas devices.



Intelligent control

- Smart grid ready
- Easy 3rd party BMS solution
- Scheduling programs
- Anti-freeze function
- 5-inch colorful controller on the front panel and an optional wired controller

Operation temperature range

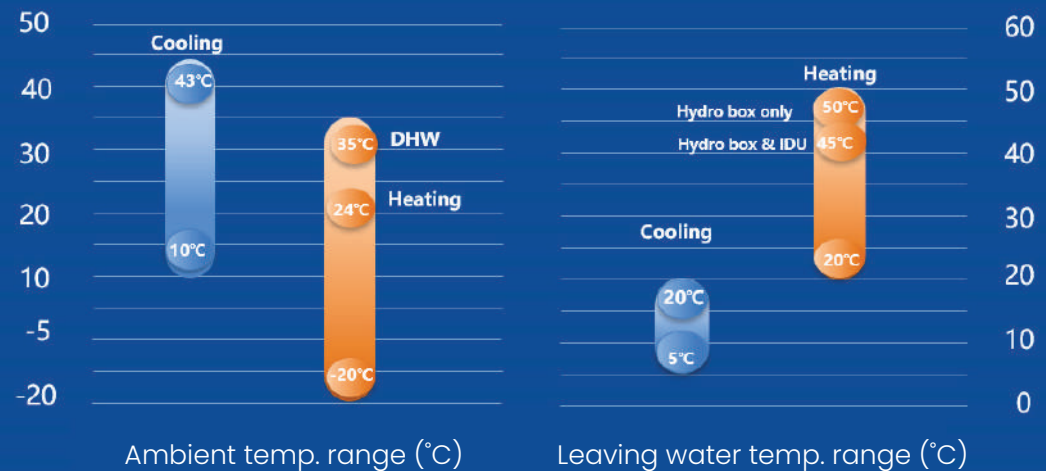

One-way cassette

Model		IMV-015C1CREDA	IMV-022C1CREDA	IMV-028C1CREDA	IMV-036C1CREDA
Capacity	Cooling (kBt/h)	5.1	7.5	9.6	12.3
	Cooling (kW)	1.5	2.2	2.8	3.6
	Heating (kBt/h)	5.8	8.5	10.9	13.7
	Heating (kW)	1.7	2.5	3.2	4
Electrical parameters	Power supply (Ph/V/Hz)	1/220-240/50/60			
Performance	Air Flow - H/M/L (m³/h)	540/400/270	540/400/270	540/400/270	650/510/390
	Sound pressure level - H/M/L (dB(A))	38/33/28	38/33/28	38/33/28	40/36/31
	Sound power level - H/M/L (dB(A))	52/47/42	52/47/42	52/47/42	54/50/45
Installation	External dimensions - W/D/H (mm)	850/540/185	850/540/185	850/540/185	850/540/185
	Shipping dimensions - W/D/H (mm)	1043/648/270	1043/648/270	1043/648/270	1043/648/270
	Net/Shipping weight (kg)	20.5/24.7	20.5/24.7	20.5/24.7	20.8/24.9
	Refrigerant liquid pipe (mm)	6.35	6.35	6.35	6.35
	Refrigerant gas pipe (mm)	9.52	9.52	9.52	12.7
Panel	Model Name	VCIP-1028REA	VCIP-1028REA	VCIP-1028REA	VCIP-1028REA
	External dimensions - W/D/H (mm)	1028/600/45	1028/600/45	1028/600/45	1028/600/45
	Shipping dimensions - W/D/H (mm)	1143/688/170	1143/688/170	1143/688/170	1143/688/170
	Net/Shipping weight (kg)	3.9/8.0	3.9/8.0	3.9/8.0	3.9/8.0
Controller	Wired (Optional)	VCW-01REA	VCW-01REA	VCW-01REA	VCW-01REA
		VCW-02CREA	VCW-02CREA	VCW-02CREA	VCW-02CREA
		VCW-03DREA	VCW-03DREA	VCW-03DREA	VCW-03DREA
	Infrared (Optional)	VCR-01CREA	VCR-01CREA	VCR-01CREA	VCR-01CREA



DC fan motor



Ultra thin design
185 mm



Butterfly wings airflow



Built-in high head drain pump



VCW-01REA



VCW-03DREA



VCW-02CREA



VCR-020REA

IMV-045C1CREDA	IMV-056C1CREDA	IMV-071C1CREDA
15.4	19.1	24.2
4.5	5.6	7.1
17.1	21.5	27.3
5	6.3	8
1/220-240/50/60		
700/530/410	820/660/510	870/690/510
41/36/32	40/36/32	42/36/32
55/50/46	54/50/46	56/50/46
850/540/185	1170/540/185	1170/540/185
1043/648/270	1363/648/270	1363/648/270
21.3/25.5	26.0/31.4	27.1/32.5
6.35	6.35	9.52
12.7	12.7	15.88
VCIP-1028REA	VCIP-1348REA	VCIP-1348REA
1028/600/45	1348/600/45	1348/600/45
1143/688/170	1463/688/170	1463/688/170
3.9/8.0	5.1/9.8	5.1/9.8
VCW-01REA	VCW-01REA	VCW-01REA
VCW-02CREA	VCW-02CREA	VCW-02CREA
VCW-03DREA	VCW-03DREA	VCW-03DREA
VCR-01CREA	VCR-01CREA	VCR-01CREA

Two-way cassette

Model		IMV-022C2CREDA	IMV-028C2CREDA	IMV-036C2CREDA	IMV-045C2CREDA	IMV-056C2CREDA		
Capacity	Cooling (kBt/h)	7.5	9.6	12.3	15.4	19.1		
	Cooling (kW)	2.2	2.8	3.6	4.5	5.6		
	Heating (kBt/h)	8.5	10.9	13.7	17.1	21.5		
	Heating (kW)	2.5	3.2	4	5	6.3		
Electrical parameters	Power supply (Ph/V/Hz)	1/220-240/50/60						
Performance	Air Flow - H/M/L (m³/h)	650/550/390	700/600/410	730/600/430	800/650/450	950/780/500		
	Sound pressure level - H/M/L (dB(A))	32/30/28	34/31/29	35/32/30	37/34/32	39/37/34		
	Sound power level - H/M/L (dB(A))	48/46/44	50/47/45	51/48/46	53/50/48	55/53/50		
Installation	External dimensions - W/D/H (mm)	1000/600/290	1000/600/290	1000/600/290	1000/600/290	1000/600/290		
	Shipping dimensions - W/D/H (mm)	1201/680/377	1201/680/377	1201/680/377	1201/680/377	1201/680/377		
	Net/Shipping weight (kg)	33/40	33/40	33/40	34/41	34/41		
	Refrigerant liquid pipe (mm)	Ø 6.35	Ø 6.35	Ø 6.35	Ø 6.35	Ø 6.35		
	Refrigerant gas pipe (mm)	Ø 25.4	Ø 25.4	Ø 25.4	Ø 25.4	Ø 25.4		
Panel	Model Name	VC2P-1160REA	VC2P-1160REA	VC2P-1160REA	VC2P-1160REA	VC2P-1160REA		
	External dimensions - W/D/H (mm)	1160/665/60	1160/665/60	1160/665/60	1160/665/60	1160/665/60		
	Shipping dimensions - W/D/H (mm)	1244/748/159	1244/748/159	1244/748/159	1244/748/159	1244/748/159		
	Net/Shipping weight (kg)	6.3/12	6.3/12	6.3/12	6.3/12	6.3/12		
Controller	Wired (Optional)	VCW-03DREA	VCW-03DREA	VCW-03DREA	VCW-03DREA	VCW-03DREA		
		VCW-02CREA	VCW-02CREA	VCW-02CREA	VCW-02CREA	VCW-02CREA		
		VCW-01REA	VCW-01REA	VCW-01REA	VCW-01REA	VCW-01REA		
	Infrared (Optional)	VCR-02OREA	VCR-02OREA	VCR-02OREA	VCR-02OREA	VCR-02OREA		



DC fan motor



Built in high head drain pump



Ceiling antifouling design



Quiet operation



VCW-01REA



VCW-03DREA



VCW-02CREA



VCR-02OREA

* 1. In case of using VCR-02OREA alone, VRR-01REA needs to be purchased.

2. VCW-01REA and VCW-03DREA have built-in infrared signal receiver. VCW-02CREA no such function.

IMV-071C2CREDA	IMV-080C2CREDA	IMV-090C2CREDA	IMV-112C2CREDA	IMV-140C2CREDA
24.2	27.3	30.7	38.2	47.8
7.1	8	9	11.2	14
27.3	30.7	34.1	42.7	54.6
8	9	10	12.5	16
1/220-240/50/60				
1000/850/700	1100/950/800	1500/1350/1110	1700/1450/1200	1950/1750/1350
40/38/35	41/39/36	42/39/36	44/40/36	46/42/38
56/54/51	57/55/52	58/55/52	60/56/52	62/58/54
1000/600/290	1400/600/290	1400/600/290	1400/600/290	1400/600/290
1201/680/377	1601/680/377	1601/680/377	1601/680/377	1601/680/377
34/41	45/54	45/54	45/54	45/54
Ø 9.52	Ø 9.52	Ø 9.52	Ø 9.52	Ø 9.52
Ø 25.4	Ø 25.4	Ø 25.4	Ø 25.4	Ø 25.4
VC2P-1160REA	VC2P-1560REA	VC2P-1560REA	VC2P-1560REA	VC2P-1560REA
1160/665/60	1560/665/60	1560/665/60	1560/665/60	1560/665/60
1244/748/159	1644/748/159	1644/748/159	1644/748/159	1644/748/159
6.3/12	8/14.5	8/14.5	8/14.5	8/14.5
VCW-03DREA	VCW-03DREA	VCW-03DREA	VCW-03DREA	VCW-03DREA
VCW-02CREA	VCW-02CREA	VCW-02CREA	VCW-02CREA	VCW-02CREA
VCW-01REA	VCW-01REA	VCW-01REA	VCW-01REA	VCW-01REA
VCR-02OREA	VCR-02OREA	VCR-02OREA	VCR-02OREA	VCR-02OREA

Compact Four-Way cassette

Model		IMV-015CCAREDA	IMV-022CCAREDA	IMV-028CCAREDA
Capacity	Cooling (kBT/h)	5.1	7.5	9.5
	Cooling (kW)	1.5	2.2	2.8
	Heating (kBT/h)	5.8	8.5	10.9
	Heating (kW)	1.7	2.5	3.2
Electrical parameters	Power supply (Ph/V/Hz)	1 / 220 ~ 240 / 50 / 60		
Performance	Air Flow - H/M/L (m³/h)	650/540/430	700/590/480	700/590/480
	Sound pressure level - H/M/L (dB(A))	32/30/29	32/30/29	32/30/29
	Sound power level - H/M/L (dB(A))	46/44/43	46/44/43	46/44/43
Installation	External dimensions - W/D/H (mm)	570/570/260	570/570/260	570/570/260
	Shipping dimensions - W/D/H (mm)	718/680/380	718/680/380	718/680/380
	Net/Shipping weight (kg)	16/19	16/19	16/19
	Refrigerant liquid pipe (mm)	6.35	6.35	6.35
	Refrigerant gas pipe (mm)	9.52	9.52	9.52
Panel	Model Name	VCP-620REA	VCP-620REA	VCP-620REA
	External dimensions - W/D/H (mm)	620/620/60	620/620/60	620/620/60
	Shipping dimensions - W/D/H (mm)	660/660/115	660/660/115	660/660/115
Controller	Wired (Optional)	VCW-01REA	VCW-01REA	VCW-01REA
		VCW-02CREA	VCW-02CREA	VCW-02CREA
	Infrared (Optional)	VCR-01CREA	VCR-01CREA	VCR-01CREA
		VCR-02OREA	VCR-02OREA	VCR-02OREA



DC fan motor



New panel design
620 x 620 mm



Fresh air inlet



Low sound level



VCW-01REA



VCW-02CREA



VCR-02OREA



VCR-01CREA

IMV-036CCAREDA	IMV-045CCAREDA	IMV-056CCAREDA
12.3	15.3	19.1
3.6	4.5	5.6
13.6	17.1	21.5
4.0	5.0	6.3
1/220-240/50/60		
700/590/480	700/590/480	700/590/480
33/30/29	33/30/29	34/32/30
47/44/43	47/44/43	48/46/44
570/570/260	570/570/260	570/570/260
718/680/380	718/680/380	718/680/380
19/22	19/22	19/22
6.35	6.35	6.35
12.7	12.7	12.7
VCP-620REA	VCP-620REA	VCP-620REA
620/620/60	620/620/60	620/620/60
660/660/115	660/660/115	660/660/115
VCW-01REA	VCW-01REA	VCW-01REA
VCW-02CREA	VCW-02CREA	VCW-02CREA
VCR-01CREA	VCR-01CREA	VCR-01CREA
VCR-02OREA	VCR-02OREA	VCR-02OREA

Round Flow Cassette

Model		IMV-022C4AREDA	IMV-028C4AREDA	IMV-036C4AREDA	IMV-045C4AREDA	IMV-056C4AREDA
Capacity	Cooling (kBT/h)	7.5	9.5	12.3	15.3	19.1
	Cooling (kW)	2.2	2.8	3.6	4.5	5.6
	Heating (kBT/h)	8.5	10.9	13.6	17.1	21.5
	Heating (kW)	2.5	3.2	4	5	6.3
Electrical parameters	Power supply (Ph/V/Hz)	1/220-230/50/60				
Performance	Air Flow - H/M/L (m³/h)	1000/810/620	1000/810/620	1000/810/620	1000/810/620	1000/810/620
	Sound pressure level - H/M/L (dB (A))	30/27/25	30/27/25	30/27/25	32/29/27	33/30/29
Installation	External dimensions - W/D/H (mm)	840/840/183	840/840/183	840/840/183	840/840/183	840/840/183
	Shipping dimensions - W/D/H (mm)	983/983/268	983/983/268	983/983/268	983/983/268	983/983/268
	Net/Shipping weight (kg)	25/28	25/28	25/28	25/28	25/28
	Refrigerant liquid pipe (mm)	6.35	6.35	6.35	6.35	6.35
	Refrigerant gas pipe (mm)	9.52	9.52	12.7	12.7	12.7
Panel	Model Name	VCP-950REA	VCP-950REA	VCP-950REA	VCP-950REA	VCP-950REA
	External dimensions - W/D/H (mm)	950/950/50	950/950/50	950/950/50	950/950/50	950/950/50
	Shipping dimensions - W/D/H (mm)	1013/1025/123	1013/1025/123	1013/1025/123	1013/1025/123	1013/1025/123
	Net/Shipping weight (kg)	6.5/9	6.5/9	6.5/9	6.5/9	6.5/9
Controller	Wired (Optional)	VCW-01REA	VCW-01REA	VCW-01REA	VCW-01REA	VCW-01REA
		VCW-02CREA	VCW-02CREA	VCW-02CREA	VCW-02CREA	VCW-02CREA
	Infrared (Optional)	VCR-01CREA	VCR-01CREA	VCR-01CREA	VCR-01CREA	VCR-01CREA
		VCR-02OREA	VCR-02OREA	VCR-02OREA	VCR-02OREA	VCR-02OREA



DC fan motor



Unique round-way air outlet, no blind spot



Innovative 4 independent air flow control



6 adjustable louver positions, 1296 air flow combinations



VCW-01REA



VCW-02CREA



VCR-02OREA



VCR-01CREA

IMV-071C4AREDA	IMV-080C4AREDA	IMV-090C4AREDA	IMV-112C4AREDA	IMV-140C4AREDA	IMV-160C4AREDA
24.2	27.3	30.7	38.2	47.7	54.6
7.1	8	9	11.2	14	16
27.3	30.7	34.1	42.6	54.6	61.2
8	9	10	12.5	16	18
1/220-230/50/60					
1380/1190/1000	1380/1190/1000	2050/1860/1670	2050/1860/1670	2100/1910/1720	2100/1910/1720
35/34/31	37/35/31	37/35/31	37/35/31	44/40/36	44/40/36
840/840/204	840/840/204	840/840/246	840/840/246	840/840/288	840/840/288
983/983/290	983/983/290	983/983/331	983/983/331	983/983/373	983/983/373
27/30	27/30	31/36	31/36	33/38	33/38
9.52	9.52	9.52	9.52	9.52	9.52
15.88	15.88	15.88	15.88	15.88	15.88
VCP-950REA	VCP-950REA	VCP-950REA	VCP-950REA	VCP-950REA	VCP-950REA
950/950/50	950/950/50	950/950/50	950/950/50	950/950/50	950/950/50
1013/1025/123	1013/1025/123	1013/1025/123	1013/1025/123	1013/1025/123	1013/1025/123
6.5/9	6.5/9	6.5/9	6.5/9	6.5/9	6.5/9
VCW-01REA	VCW-01REA	VCW-01REA	VCW-01REA	VCW-01REA	VCW-01REA
VCW-02CREA	VCW-02CREA	VCW-02CREA	VCW-02CREA	VCW-02CREA	VCW-02CREA
VCR-01CREA	VCR-01CREA	VCR-01CREA	VCR-01CREA	VCR-01CREA	VCR-01CREA
VCR-02OREA	VCR-02OREA	VCR-02OREA	VCR-02OREA	VCR-02OREA	VCR-02OREA

Floor - Ceiling

Model		IMV-028CFAREDA	IMV-036CFAREDA	IMV-045CFAREDA	IMV-056CFAREDA
Capacity	Cooling (kBT/h)	9.5	12.3	15.4	19.1
	Cooling (kW)	2.8	3.6	4.5	5.6
	Heating (kBT/h)	10.9	13.6	17.1	21.5
	Heating (kW)	3.2	4	5	6.3
Electrical parameters	Power supply (Ph/V/Hz)	1/220-230/50/60			
Performance	Air Flow - H/M/L (m³/h)	820/750/690	820/750/690	950/820/690	950/820/690
	Sound pressure level - H/M/L (dB (A))	38/36/34	38/36/34	42/38/35	42/38/35
	Sound power level - H/M/L (dB (A))	52/50/47	52/50/47	55/51/48	55/51/48
Installation	External dimensions - W/D/H (mm)	1000/230/680	1000/230/680	1000/230/680	1000/230/680
	Shipping dimensions - W/D/H (mm)	1100/305/779	1100/305/779	1100/305/779	1100/305/779
	Net/Shipping weight (kg)	27.9/33.6	27.9/33.6	27.9/33.6	27.9/33.6
	Refrigerant liquid pipe (mm)	6.35	6.35	6.35	6.35
	Refrigerant gas pipe (mm)	9.52	12.7	12.7	12.7
Controller	Wired (Optional)	VCW-03DREA	VCW-03DREA	VCW-03DREA	VCW-03DREA
		VCW-02CREA	VCW-02CREA	VCW-02CREA	VCW-02CREA
		VCW-01REA	VCW-01REA	VCW-01REA	VCW-01REA
	Infrared (Optional)	VCR-02OREA	VCR-02OREA	VCR-02OREA	VCR-02OREA



DC fan motor



Automatic horizontal and vertical swing



Flexible installation, on the floor or on the ceiling



Reserved fresh air inlet



VCW-01REA



VCW-03DREA



VCW-02CREA



VCR-02OREA

IMV-07CFAREDA	IMV-080CFAREDA	IMV-090CFAREDA	IMV-112CFAREDA	IMV-140CFAREDA
24.2	27.3	30.7	38.2	48,0
7.1	8	9	11.2	14,0
27.3	30.7	34.1	42.6	55,0
8	9	10	12.5	16,0
1/220-230/50/60				
1420/1270/1240	1570/1420/1240	1570/1420/1240	2110/1990/1750	2110/1990/1750
46/44/41	47/44/41	47/44/41	50/46/43	50/46/43
60/58/54	61/58/54	61/58/55	63/60/57	63/60/57
1325/230/680	1325/230/680	1325/230/680	1650/230/680	1650/230/680
1425/305/779	1425/305/779	1425/305/779	1750/305/779	1750/305/779
35.8/42.1	35.8/42.1	35.8/42.1	43.5/50.5	43.5/50.5
9.52	9.52	9.52	9.52	9,52
15.88	15.88	15.88	15.88	15,88
VCW-03DREA	VCW-03DREA	VCW-03DREA	VCW-03DREA	VCW-03DREA
VCW-02CREA	VCW-02CREA	VCW-02CREA	VCW-02CREA	VCW-02CREA
VCW-01REA	VCW-01REA	VCW-01REA	VCW-01REA	VCW-01REA
VCR-02OREA	VCR-02OREA	VCR-02OREA	VCR-02OREA	VCR-02OREA

Slim Duct

Model		IMV-015DTLAREDA	IMV-022DTLAREDA	IMV-028DTLAREDA
Capacity	Cooling (kBT/h)	5.1	7.5	9.5
	Cooling (kW)	1.5	2.2	2.8
	Heating (kBT/h)	5.8	8.5	10.9
	Heating (kW)	1.7	2.5	3.2
Electrical parameters	Power supply (Ph/V/Hz)	1/220-230/50/60		
Performance	Air Flow - H/M/L (m ³ /h)	430/370/310	480/420/360	480/420/360
	Sound pressure level - H/M/L (dB (A))	26/22/19	27/23/20	27/23/20
	Sound power level - H/M/L (dB (A))	40/36/33	41/37/34	41/37/34
Installation	External dimensions - W/D/H (mm)	850/420/185	850/420/185	850/420/185
	Shipping dimensions - W/D/H (mm)	1045/540/270	1045/540/270	1045/540/270
	Net/Shipping weight (kg)	16.5/21.5	17.5/22.5	17.5/22.5
	Refrigerant liquid pipe (mm)	6.35	6.35	6.35
	Refrigerant gas pipe (mm)	9.52	9.52	9.52
	Static Pressure - Standard/Max. (Pa)	0/15/30	0/15/30	0/15/30
Panel	Panel model	VDP-890DREA	VDP-890DREA	VDP-890DREA
	External dimensions - W/D/H (mm) - outlet panel	890/190/100 (outlet panel)	890/190/100 (outlet panel)	890/190/100 (outlet panel)
	External dimensions - W/D/H (mm) - inlet panel	890/290.5/32.4 (inlet panel)	890/290.5/32.4 (inlet panel)	890/290.5/32.4 (inlet panel)
	Shipping dimensions - W/D/H (mm)	938/335/220	938/335/220	938/335/220
	Net/Shipping weight (mm)	4/5	4/5	4/5
Drain pump	O - optional, S - standard, W - without	S	S	S
Controller	Wired (Optional)	VCW-03DREA	VCW-03DREA	VCW-03DREA
		VCW-02CREA	VCW-02CREA	VCW-02CREA
		VCW-01REA	VCW-01REA	VCW-01REA
	Infrared (Optional)	VCR-02OREA	VCR-02OREA	VCR-02OREA

 DC fan motor
 Super slim design, only 185 mm
 Rear or bottom air return
 Built-in high head drain pump

 **VCW-01REA**
 **VCW-03DREA**
 **VCW-02CREA**
 **VCR-02OREA**

* 1. VCW-01REA and VCW-03DREA have built-in infrared signal receiver. VCW-02CREA does not have such function.
 2. The units with panel can directly use the remote controller VCR-02OREA.

IMV-036DTLAREDA	IMV-045DTLAREDA	IMV-056DTLAREDA	IMV-071DTLAREDA
12.3	15.3	19.1	24.2
3.6	4.5	5.6	7.1
13.6	17.1	21.5	27.3
4	5	6.3	8
1 / 220 - 230 / 50 / 60			
550/430/370	600/540/460	800/690/580	930/850/750
30/27/24	32/29/26	33/30/27	36/33/30
44/41/38	46/43/40	47/44/41	50/47/43
850/420/185	850/420/185	1170/420/185	1170/420/185
1045/540/270	1045/540/270	1365/540/270	1365/540/270
17.5/22.5	18.5/23.5	22.2/28.2	24/30
6.35	6.35	6.35	9.52
12.7	12.7	12.7	15.88
0/15/30	0/15/30	0/15/30	0/15/30
VDP-890DREA	VDP-890DREA	VDP-1210DREA	VDP-1210DREA
890/190/100 (outlet panel)	890/190/100 (outlet panel)	1210/190/100 (outlet panel)	1210/190/100 (outlet panel)
890/290.5/32.4 (inlet panel)	890/290.5/32.4 (inlet panel)	1210/290.5/32.4 (inlet panel)	1210/290.5/32.4 (inlet panel)
938/335/220	938/335/220	1258/335/220	1258/335/220
4/5	4/5	5/6	5/6
S	S	S	S
VCW-03DREA	VCW-03DREA	VCW-03DREA	VCW-03DREA
VCW-02CREA	VCW-02CREA	VCW-02CREA	VCW-02CREA
VCW-01IREA	VCW-01IREA	VCW-01IREA	VCW-01IREA
VCR-02OREA	VCR-02OREA	VCR-02OREA	VCR-02OREA

High ESP Duct

Model		IMV-015DTHAREDA	IMV-022DTHAREDA	IMV-028DTHAREDA	IMV-036DTHAREDA	IMV-045DTHAREDA
Capacity	Cooling (HP)	0.5	0.8	1.0	1.25	1.7
	Cooling (kBT/h)	5.1	7.5	9.6	12.3	15.3
	Cooling (kW)	1.5	2.2	2.8	3.6	4.5
	Heating (kBT/h)	5.8	8.5	10.9	13.7	17
	Heating (kW)	1.7	2.5	3.2	4	5
Electrical parameters	Power supply (Ph/V/Hz)	1/220-240/50/60				
Dimensions	Net Product (mm)	700/700/248	700/700/248	700/700/248	700/700/248	700/700/248
	Shipping Product (mm)	901/853/305	901/853/305	901/853/305	901/853/305	901/853/305
Weight	Product Net/Shipping (kg)	27/29.5	27/29.5	27/29.5	27/29.5	28.5/31
Fan	Static Pressure - Standard/Max (mm)	20/200	20/200	20/200	20/200	20/200
	Air flow - H/M/L (m³/h)	515/440/390	545/470/390	545/470/390	570/495/420	700/625/550
Sound level	Sound pressure level - H/M/L (dB(A))	29/27/25	30/28/25	30/28/25	31/29/27	32/30/28
	Sound power level - H/M/L (dB(A))	41/39/37	42/40/37	42/40/37	43/41/39	44/42/40
Piping	Refrigerant liquid pipe (mm)	6.35	6.35	6.35	6.35	6.35
	Refrigerant gas pipe. (mm)	9.52	9.52	9.52	12.7	12.7
Drain pump	O - optional, S - standard, W - without	S	S	S	S	S
Controller	Wired (Optional)	VCW-01REA	VCW-01REA	VCW-01REA	VCW-01REA	VCW-01REA
		VCW-02CREA	VCW-02CREA	VCW-02CREA	VCW-02CREA	VCW-02CREA
		VCW-03DREA	VCW-03DREA	VCW-03DREA	VCW-03DREA	VCW-03DREA
	Infrared (Optional)	VCR-02OREA	VCR-02OREA	VCR-02OREA	VCR-02OREA	VCR-02OREA



DC fan motor



Only 248 mm thick



Built-in drain pump



50/60 Hz Power supply



VCW-01REA



VCW-03DREA



VCW-02CREA



VCR-02OREA

* 1. VCW-01REA and VCW-03DREA have built-in infrared signal receiver. VCW-02CREA does not have such function.

IMV-056DTHAREDA	IMV-071DTHAREDA	IMV-080DTHAREDA	IMV-090DTHAREDA	IMV-112DTHAREDA	IMV-140DTHAREDA	IMV-160DTHAREDA
2.0	2.5	3.0	3.2	4.0	5.0	6.0
19.1	24.2	27.3	30.7	38.2	47.8	54.6
5.6	7.1	8	9	11.2	14	16
21.5	27.3	30.7	34.1	44.4	55.6	61.4
6.3	8	9	10	13	16.3	18
1 / 220 ~ 240 / 50 / 60						
1100/700/248	1100/700/248	1100/700/248	1100/700/248	1500/700/248	1500/700/248	1500/700/248
1301/853/305	1301/853/305	1301/853/305	1301/853/305	1701/853/305	1701/853/305	1701/853/305
36.8/39.8	36.8/39.8	36.8/39.8	39.4/42.4	48.3/55.5	51.3/58.5	51.3/58.5
20/200	20/200	20/200	20/180	20/180	20/180	20/180
915/765/640	1275/1050/875	1275/1050/875	1450/1200/1000	2000/1700/1400	2150/1750/1400	2350/1950/1600
33/31/29	34/31/29	35/33/30	36/33/30	38/35/32	40/36/32	42/38/34
45/43/41	46/43/41	47/45/42	48/45/42	50/47/44	52/48/44	54/50/46
6.35	9.52	9.52	9.52	9.52	9.52	9.52
12.7	15.88	15.88	15.88	15.88	15.88	15.88
S	S	S	S	S	S	S
VCW-01REA	VCW-01REA	VCW-01REA	VCW-01REA	VCW-01REA	VCW-01REA	VCW-01REA
VCW-02CREA	VCW-02CREA	VCW-02CREA	VCW-02CREA	VCW-02CREA	VCW-02CREA	VCW-02CREA
VCW-03DREA	VCW-03DREA	VCW-03DREA	VCW-03DREA	VCW-03DREA	VCW-03DREA	VCW-03DREA
VCR-02OREA	VCR-02OREA	VCR-02OREA	VCR-02OREA	VCR-02OREA	VCR-02OREA	VCR-02OREA

High ESP Duct

Model		IMV-226DTHAREDA	IMV-280DTHAREDA
Power supply (PH/V/Hz)		1/220-240/50/60	
Cooling	Capacity (kBT/h)	77.1	95.5
	Capacity (kW)	22.6	28.0
Heating	Capacity (kBT/h)	86	107.5
	Capacity (kW)	25.2	31.5
	Power input (W)	610.	680
Air filter	Material	PP	PP
	Mesh	30	30
	Pressure drop (Pa)	5	5
Piping dimension	Gas pipe (mm)	Ø 22.22	Ø 22.22
	Liquid pipe (mm)	Ø 12.7	Ø 12.7
	Drain hose (mm)	Ø 25	Ø 25
Sound pressure level - S/H/M/L (dB(A))		53/50/48/46	54/51/49/47
Sound power level - S/H/M/L (dB(A))		67/64/62/60	68/65/63/61
Standard static pressure (Pa)		100	100
Max. static pressure (Pa)		300	300
Indoor air flow - S/H/M/L (m³/h)		4000/3600/3200/2700	4500/4100/3700/ 3300
Dimension - W/D/H (mm)		1333/750/497	1333/750/497
Packing - W/D/H (mm)		1558/896/668	1558/896/668
Net weight (kg)		87	87
Gross weight (kg)		109	109



DC fan motor

300 Pa

Max. ESP 300 Pa

28 kW

Max. capacity 28 kw

50/60 Hz

Power supply



VCW-02CREA

Built in floor standing

Model		IMV-022CTCAREAA	IMV-028CTCAREAA	IMV-036CTCAREAA	IMV-045CTCAREAA	IMV-056CTCAREAA	IMV-071CTCAREAA
Capacity	Cooling (kBT/h)	7.5	9.5	12.3	15.3	19.1	24.2
	Cooling (kW)	2.2	2.8	3.6	4.5	5.6	7.1
	Heating (kBT/h)	8.5	10.9	13.6	17.1	21.5	27.3
	Heating (kW)	2.5	3.2	4	5	6.3	8
Electrical parameters	Power supply (Ph/V/Hz)	1 / 220 ~ 230 / 50 / 60					
Performance	Air flow (m³/h)	750/650/550	750/650/550	750/650/550	950/830/720	950/830/720	950/830/720
	Sound pressure level - H/M/L (dB(A))	38/35/33	38/35/33	40/37/35	40/37/35	42/39/36	42/39/36
	Sound power level - H/M/L (dB(A))	51/48/46	51/48/46	53/50/48	53/50/48	55/52/49	55/52/49
Installation	External dimensions - W/D/H (mm)	1116/221/624	1116/221/624	1116/221/624	1116/221/624	1116/221/624	1116/221/624
	Shipping dimensions- W/D/H (mm)	1425/315/685	1425/315/685	1425/315/685	1425/315/685	1425/315/685	1425/315/685
	Net/Shipping weight (Kg)	29/37	29/37	29/37	31/39	31/39	31/39
	Refrigerant liquid pipe (mm)	6.35	6.35	6.35	6.35	6.35	9.52
	Refrigerant gas pipe (mm)	9.52	9.52	12.7	12.7	12.7	15.88
	Static Pressure (Pa)	0 / 30					
Controller	Wired (Optional)	VCW-03DREA	VCW-03DREA	VCW-03DREA	VCW-03DREA	VCW-03DREA	VCW-03DREA
		VCW-02CREA	VCW-02CREA	VCW-02CREA	VCW-02CREA	VCW-02CREA	VCW-02CREA
		VCW-01REA	VCW-01REA	VCW-01REA	VCW-01REA	VCW-01REA	VCW-01REA
	Infrared (Optional)	VCR-02OREA	VCR-02OREA	VCR-02OREA	VCR-02OREA	VCR-02OREA	VCR-02OREA



Require very little installation space: only 221 mm



Good solution for installation beneath a window



High efficiency filter fitted as standard



Power supply



VCW-01REA



VCW-03DREA



VCW-02CREA

Console

Model		IMV-015CTAREDA	IMV-022CTAREDA	IMV-028CTAREDA	IMV-036CTAREDA	IMV-045CTAREDA	IMV-050CTAREDA
Capacity	Cooling (kBT/h)	5.1	7.5	9.5	12.3	15.3	17
	Cooling (kW)	1.5	2.2	2.8	3.6	4.5	5
	Heating (kBT/h)	5.8	8.5	10.9	13.6	17	18.5
	Heating (kW)	1.7	2.6	3.2	4	5	5.5
Electrical parameters	Power supply (Ph/V/Hz)	1/220-230/50/60					
Performance	Air flow - H (m³/h)	540/460/390/310/270	540/460/390/310/270	540/460/390/310/270	580/500/420/350/270	620/540/460/390/270	620/540/460/390/270
	Sound pressure level - H/M/L (dB (A))	45/42/38/33/30	45/42/38/33/30	45/42/38/33/30	47/44/40/36/30	48/45/42/38/30	48/45/42/38/30
	Sound power level - H/M/L (dB)	58/55/52/48/45	58/55/52/48/45	58/55/52/48/45	60/57/54/51/47	61/58/55/42/48	61/58/55/42/48
Installation	External dimensions - W/D/H (mm)	700/210/600	700/210/600	700/210/600	700/210/600	700/210/600	700/210/600
	Shipping dimensions- W/D/H (mm)	783/303/695	783/303/695	783/303/695	783/303/695	783/303/695	783/303/695
	Net/Shipping weight (Kg)	15.2/18.7	15.2/18.7	15.2/18.7	15.2/18.7	15.2/18.7	15.2/18.7
	Refrigerant liquid pipe (mm)	6.35	6.35	6.35	6.35	6.35	6.35
	Refrigerant gas pipe (mm)	12.7	12.7	12.7	12.7	12.7	12.7
Controller	Wired (Optional)	VCW-01REA	VCW-01REA	VCW-01REA	VCW-01REA	VCW-01REA	VCW-01REA
	Infrared (Optional)	VCR-02OREA	VCR-02OREA	VCR-02OREA	VCR-02OREA	VCR-02OREA	VCR-02OREA



DC fan motor



Air discharge through top and bottom



Space saving



Quiet operation



VCW-01REA



VCR-02OREA

High Wall

Model		IMV-015CHAREDA IMV-015CHDAREDA IMV-015CHAREDAV IMV-015CHDAREDAV	IMV-022CHAREDA IMV-022CHDAREDA IMV-022CHAREDAV IMV-022CHDAREDAV	IMV-028CHAREDA IMV-028CHDAREDA IMV-028CHAREDAV IMV-028CHDAREDAV	IMV-036CHAREDA IMV-036CHDAREDA IMV-036CHAREDAV IMV-036CHDAREDAV	IMV-045CHAREDA IMV-045CHDAREDA IMV-045CHAREDAV IMV-045CHDAREDAV	IMV-056CHAREDA IMV-056CHDAREDA IMV-056CHAREDAV IMV-056CHDAREDAV	IMV-071CHAREDA IMV-071CHDAREDA IMV-071CHAREDAV IMV-071CHDAREDAV	IMV-080CHAREDA IMV-080CHDAREDAV	IMV-090CHAREDA IMV-090CHDAREDAV	
Capacity	Cooling (kBT/h)	5.1	7.5	9.5	12.3	15.3	19.1	24.2	27.3	30.7	
	Cooling (kW)	1.5	2.2	2.8	3.6	4.5	5.6	7.1	8	9	
	Heating (kBT/h)	5.8	8.5	10.9	13.6	17.1	21.5	27.3	30.7	34.1	
	Heating (kW)	1.7	2.5	3.2	4	5	6.3	8	9	10	
Electrical parameters	Power supply (Ph/V/Hz)	1/220-240/50/60					1 / 220 ~ 240 / 50 / 60				
Performance	Air flow (m³/h)	500/430/370	550/480/420	600/530/470	630/560/500	800/720/650	920/800/720	1010/920/800	1500/1400/1300	1600/1500/1400	
	Sound pressure level H/M/L (dB (A))	33/31/29	35/31/29	36/31/29	37/33/29	39/36/34	40/39/35	44/40/36	48/43/40	49/44/41	
	Sound power level H/M/L (dB (A))	49/46/41	50/47/42	52/48/44	54/51/50	56/53/51	57/54/52	58/56/54	60/57/53	61/58/54	
Installation	External dimensions W/D/H (mm)	855/208/280	855/208/280	855/208/280	855/208/280	1115/243/336	1115/243/336	1115/243/336	1316/270/365	1316/270/365	
	Shipping dimensions W/D/H (mm)	954/279/355 *1054/279/355	954/279/355 *1054/279/355	954/279/355 *1054/279/355	954/279/355 *1054/279/355	1206/342/418 *1306/342/418	1206/342/418 *1306/342/418	1206/342/418 *1306/342/418	1403/384/463 *1503/384/463	1403/384/463 *1503/384/463	
	Net/Shipping weight (kg)	9.9/12 *9.9/14.2	9.9/12 *9.9/14.2	9.9/12 *9.9/14.2	9.9/12 *9.9/14.2	15.8/18.9 *15.8/21.2	15.8/18.9 *15.8/21.2	15.8/18.9 *15.8/21.2	21.8/26.3 *21.8/27.2	21.8/26.3 *21.8/27.2	
	Refrigerant liquid pipe (mm)	6.35	6.35	6.35	6.35	6.35	6.35	9.52	9.52	9.52	
	Refrigerant gas pipe (mm)	9.52	9.52	9.52	12.7	12.7	12.7	15.88	15.88	15.88	
Controller	Wired (Optional)	VCW-03DREA	VCW-03DREA	VCW-03DREA	VCW-03DREA	VCW-03DREA	VCW-03DREA	VCW-03DREA	VCW-03DREA	VCW-03DREA	
		VCW-02CREA	VCW-02CREA	VCW-02CREA	VCW-02CREA	VCW-02CREA	VCW-02CREA	VCW-02CREA	VCW-02CREA	VCW-02CREA	
		VCW-01REA	VCW-01REA	VCW-01REA	VCW-01REA	VCW-01REA	VCW-01REA	VCW-01REA	VCW-01REA	VCW-01REA	
	Infrared (Optional)	VCR-02OREA	VCR-02OREA	VCR-02OREA	VCR-02OREA	VCR-02OREA	VCR-02OREA	VCR-02OREA	VCR-02OREA	VCR-02OREA	



DC fan motor



Hidden display



Built-in EEV



Quiet operation



VCW-01REA



VCW-03DREA



VCW-02CREA



VCR-02OREA

Hydro box

Model		IMV-090HMAREW	IMV-160HMAREW	IMV-310HMAREW
Nominal capacity	Cooling ¹ (kW)	7	14	28
	Heating ² (kW)	9	16	31
Dimensions Unit - H/W/D (mm)		850/480/310	850/480/310	850/480/310
Weight Unit (kg)		56	56	52
Installation place - Indoor/outdoor		Indoor	Indoor	Indoor
Combination ratio	Only hydro module (%)	80-100	80-100	80-100
	Hydro box+IDUs (%)	50-130	50-130	50-130
Cooling Ambient	Min. - Max. (°CDB)	10-43	10-43	10-43
Cooling Water side	Min. - Max. (°C)	5-20	5-20	5-20
Heating Ambient	Min. - Max. (°C)	-20-24	-20-24	-20-24
Water side	Min. - Max. (°C)	20-50	20-50	20-50
Sound pressure level	Cooling/Heating (dB(A))	29/ 32	29/32	29/32
Sound power level (dB(A))		42	46	48
Water flow rate	Min-Standard (L/min)	18/26	32/46	63/90
Water circuit Piping diameter	Inlet (inch)	1	1	1-1/4
	Outlet (inch)	1	1	1-1/4
Refrigerant Type		R410A		
Gas side - connection type (mm)		15.88	15.88	19.05
Liquid side - connection type (mm)		9.52	9.52	9.52
Power supply (Ph/Hz/V)		1/ 50/ 220-240		
ODU compatibility		VMV 5, VMV 5-R, VMV 5-H, VMV S 8-10-12HP		
(1) Tamb 35°C - LWE 18°C (DT=5°C)				
(2) DB/WB 7°C/6°C - LWC 35°C (DT=5°C)				



DC pump



Intelligent control



Heating + DHW

Dimensions

One way cassette

IMV-015C1CREDA, IMV-022C1CREDA, IMV-028C1CREDA, IMV-036C1CREDA, IMV-045C1CREDA, IMV-056C1CREDA, IMV-071C1CREDA

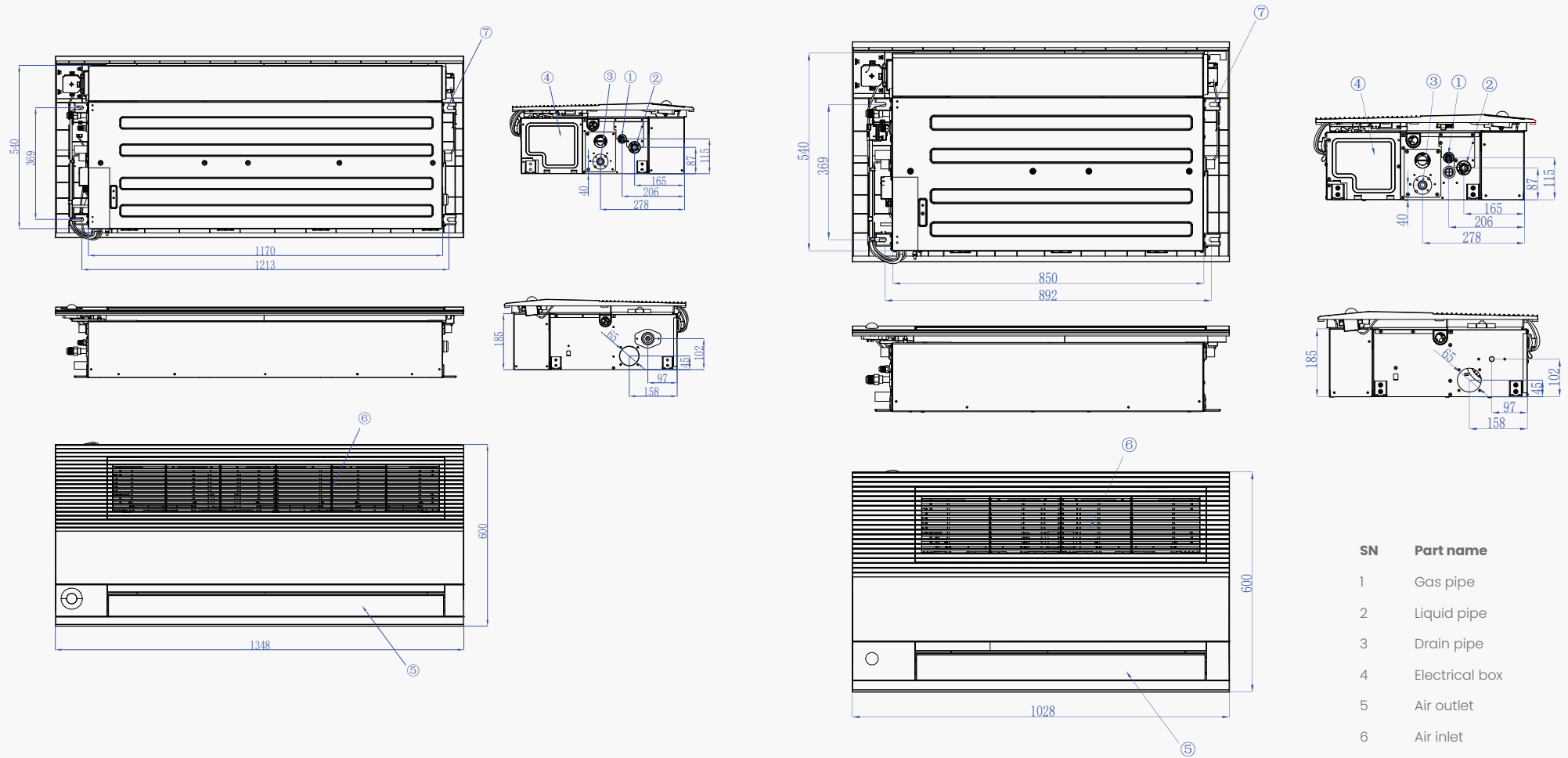

SN	Part name
1	Gas pipe
2	Liquid pipe
3	Drain pipe
4	Electrical box
5	Air outlet
6	Air inlet
7	Pothook

Dimensions

Two way cassette

IMV-022C2CREDA, IMV-028C2CREDA, IMV-036C2CREDA, IMV-045C2CREDA, IMV-056C2CREDA
 IMV-071C2CREDA, IMV-080C2CREDA, IMV-090C2CREDA, IMV-112C2CREDA, IMV-140C2CREDA

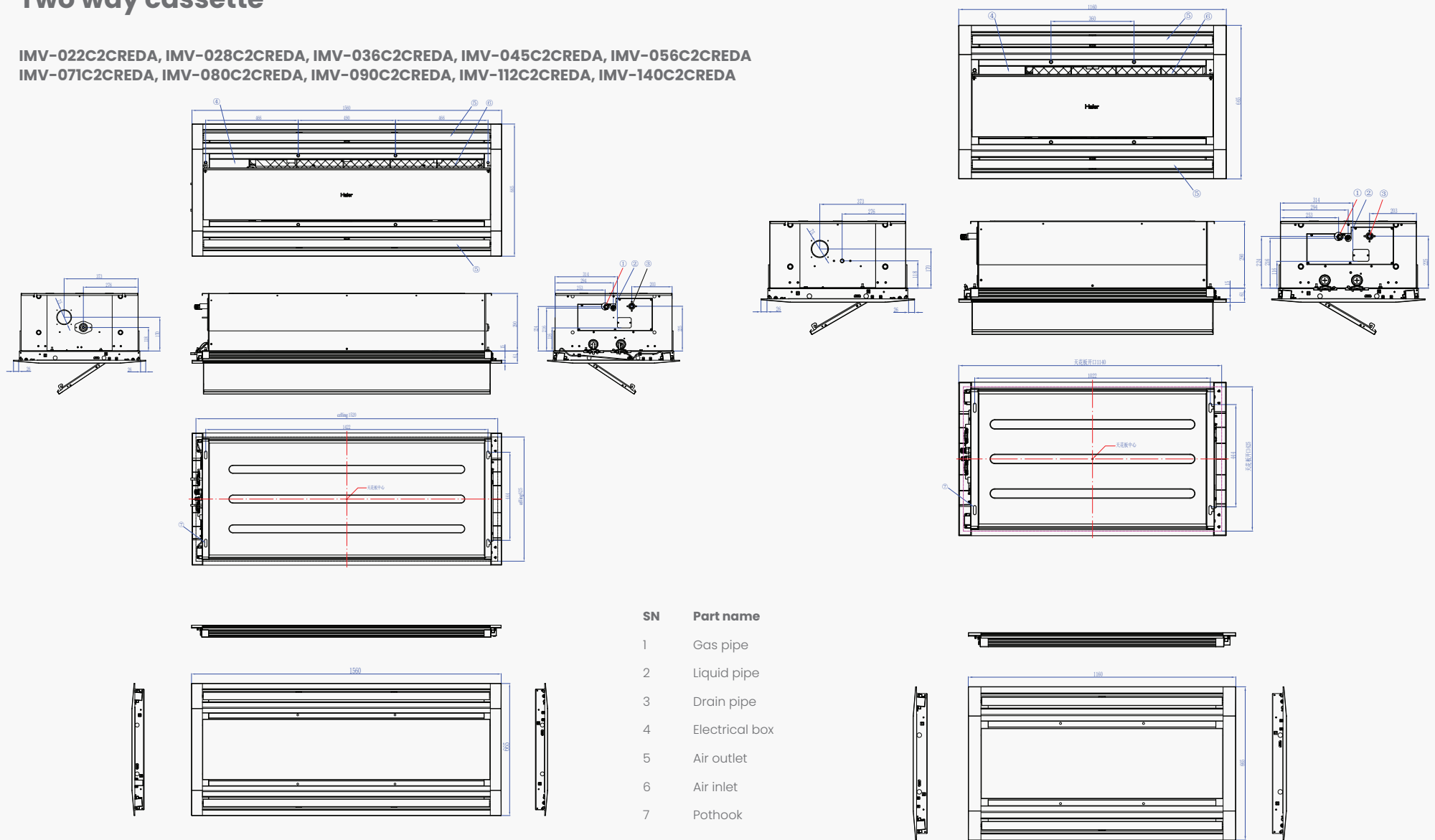

SN	Part name
1	Gas pipe
2	Liquid pipe
3	Drain pipe
4	Electrical box
5	Air outlet
6	Air inlet
7	Pothook

Compact Four Way Cassette

IMV-015CCAREDA, IMV-022CCAREDA, IMV-028CCAREDA,
IMV-036CCAREDA, IMV-045CCAREDA, IMV-056CCAREDA

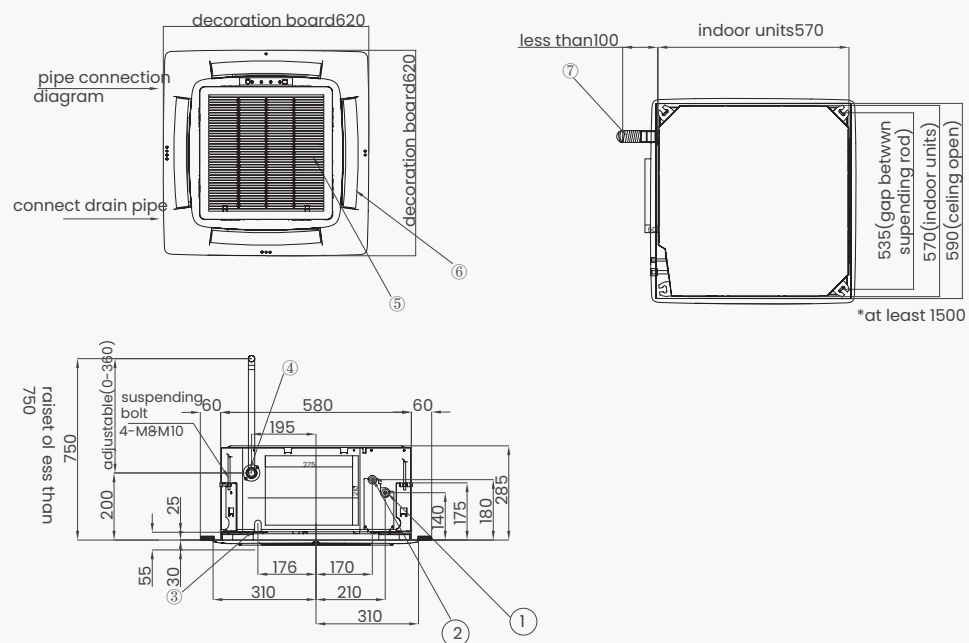

SN	Part name
1	Connection port of gas pipe
2	Connection of liquid pipe
3	Wiring connection port of motor / pumping motor
4	Connect drain pipe
5	Inlet grill
6	Outlet grill
7	Drain hose (accessory)

Round Flow Cassette

IMV-022C4AREDA, IMV-028C4AREDA, IMV-036C4AREDA, IMV-045C4AREDA,
IMV-056C4AREDA, IMV-071C4AREDA, IMV-080C4AREDA, IMV-090C4AREDA,
IMV-112C4AREDA, IMV-140C4AREDA, IMV-160C4AREDA

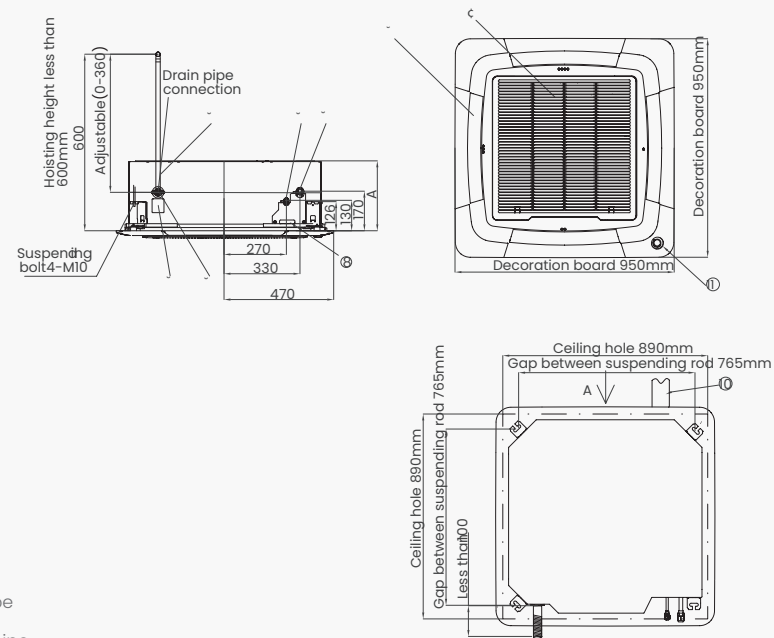

Code	Name
1	Gas pipe
2	Liquid pipe
3	Observe plate
4	Drain pipe
5	Air return grille
6	Air outlet
7	Drain soft pipe (accessory)
8	Power supply inlet
9	PQline inlet
10	Fresh air inlet
11	Move eye (optional)

Dimensions

Floor - ceiling

IMV-071CFAREDA, IMV-080CFAREDA, IMV-090CFAREDA

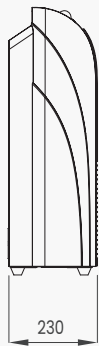
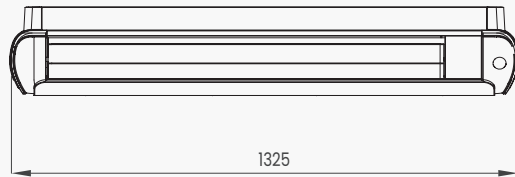

IMV-028CFAREDA, IMV-036CFAREDA,
IMV-045CFAREDA, IMV-056CFAREDA

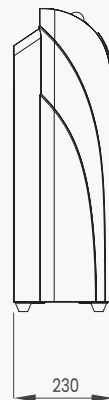
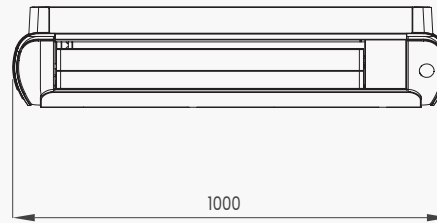
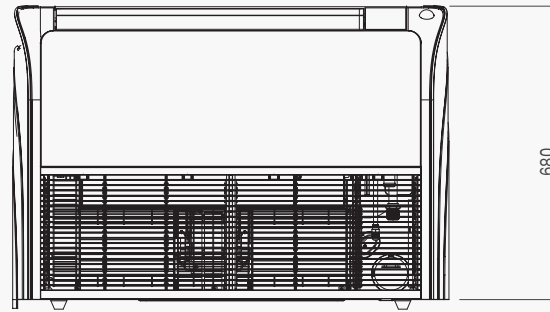

IMV-112CFAREDA, IMV-140CFAREDA

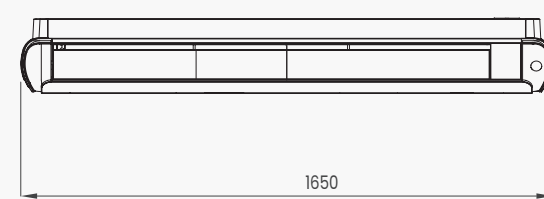
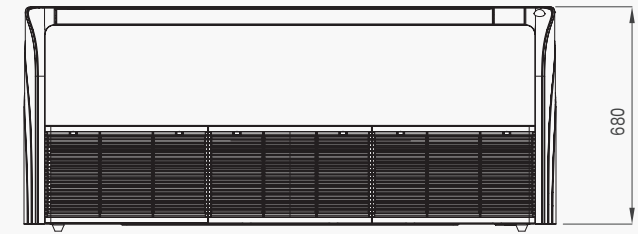

Slim Duct

Slim Duct (0 / 15 / 30 Pa): IMV-015DTLAREDA, IMV-022DTLAREDA, IMV-028DTLAREDA, IMV-036DTLAREDA, IMV-045DTLAREDA

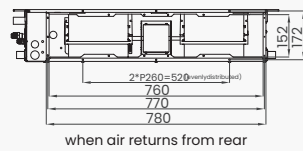
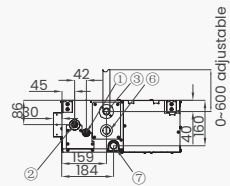
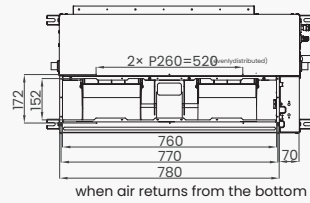
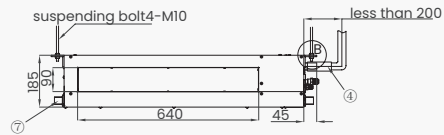
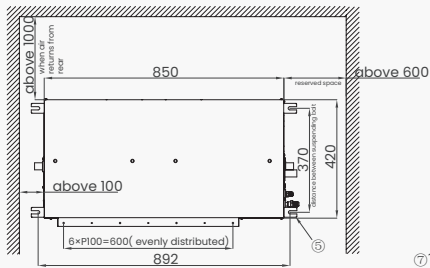

- | SN | Part name |
|----|------------------------|
| 1 | Liquid pipe connection |
| 2 | Gas pipe connection |
| 3 | Drain hose with pump |
| 4 | Drain hose (accessory) |
| 5 | Suspending point |
| 6 | Checking hole |
| 7 | Water drainage outlet |

Slim duct

Slim Duct (0 / 15 / 30 Pa): IMV-056DTLAREDA, IMV-071DTLAREDA

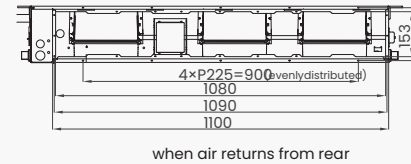
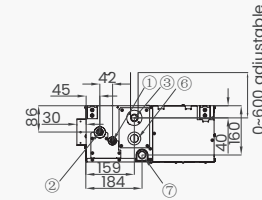
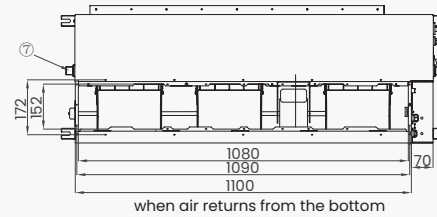
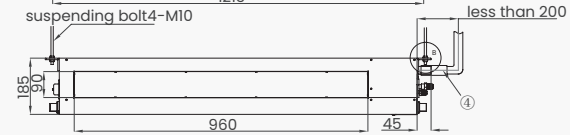
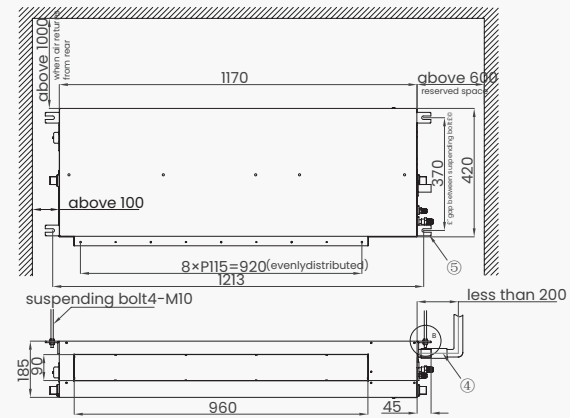

- | SN | Part name |
|----|------------------------|
| 1 | Liquid pipe connection |
| 2 | Gas pipe connection |
| 3 | Drain hose with pump |
| 4 | Drain hose (accessory) |
| 5 | Suspending point |
| 6 | Checking hole |
| 7 | Water drainage outlet |

Dimensions

High ESP Duct

High ESP Duct (20 / 200 Pa): IMV-015DTHAREDA, IMV-022DTHAREDA, IMV-028DTHAREDA, IMV-036DTHAREDA, IMV-045DTHAREDA

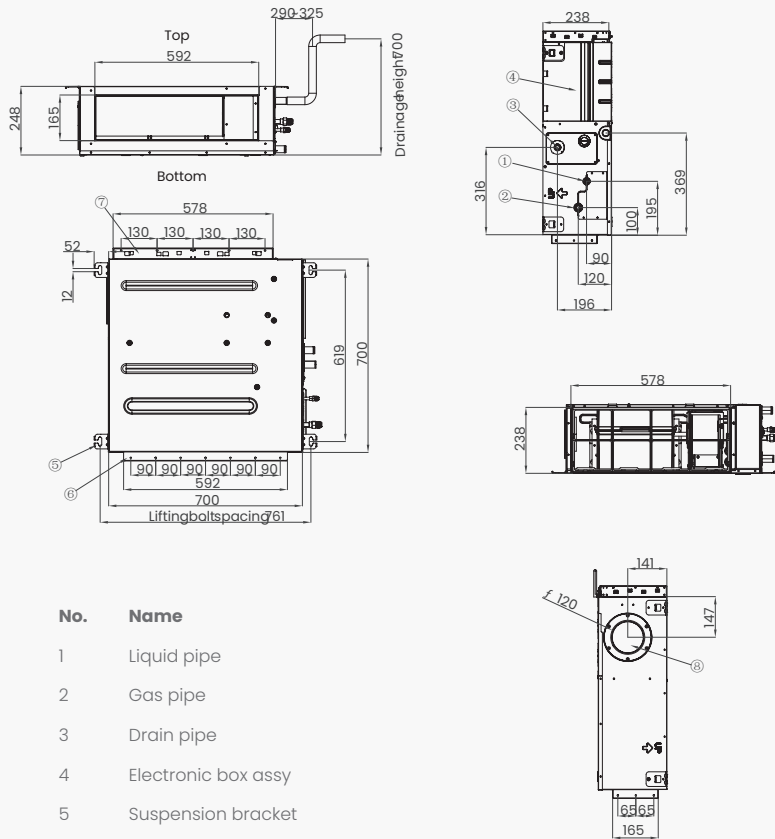

High ESP Duct (20 / 200 Pa): IMV-056CTAREDA, IMV-071CTAREDA, IMV-080CTAREDA, IMV-090CTAREDA

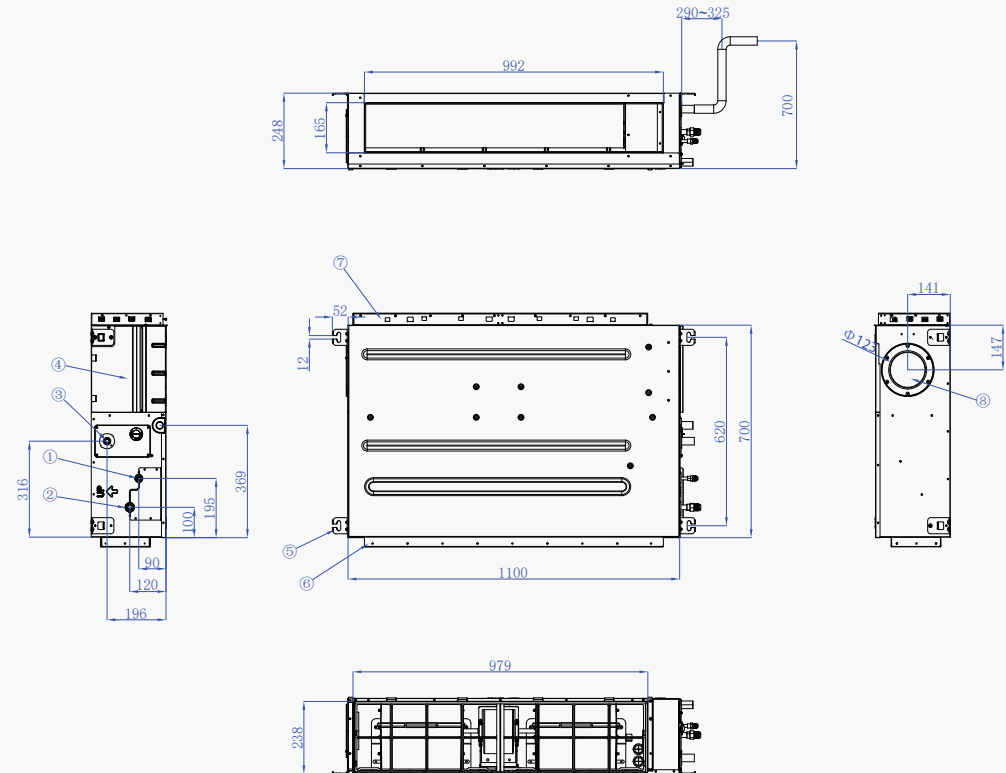

High ESP Duct

High ESP Duct (20 / 200 Pa): IMV-112DTHAREDA, IMV-140DTHAREDA, IMV-160DTHAREDA

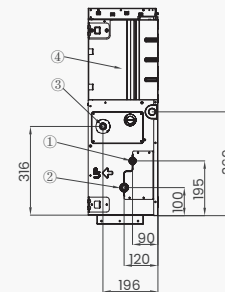
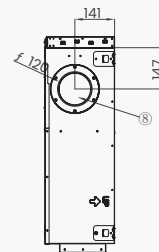
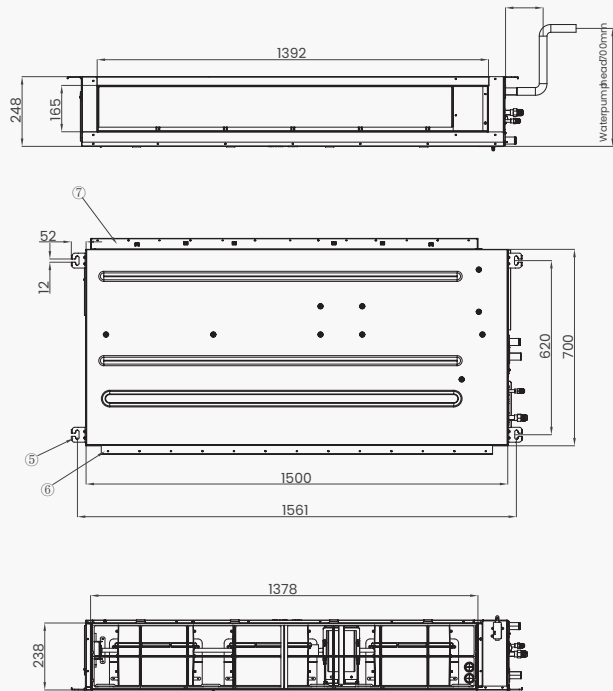

- | No. | Name |
|-----|----------------|
| 1 | Liquid pipe |
| 2 | Gas pipe |
| 3 | Drain pipe |
| 4 | Electronic box |
| 5 | Hanging foot |
| 6 | Air outlet |
| 7 | Air return |
| 8 | Fresh air |

Dimensions

High ESP Duct

IMV-226DTHAREDA, IMV-280DTHAREDA

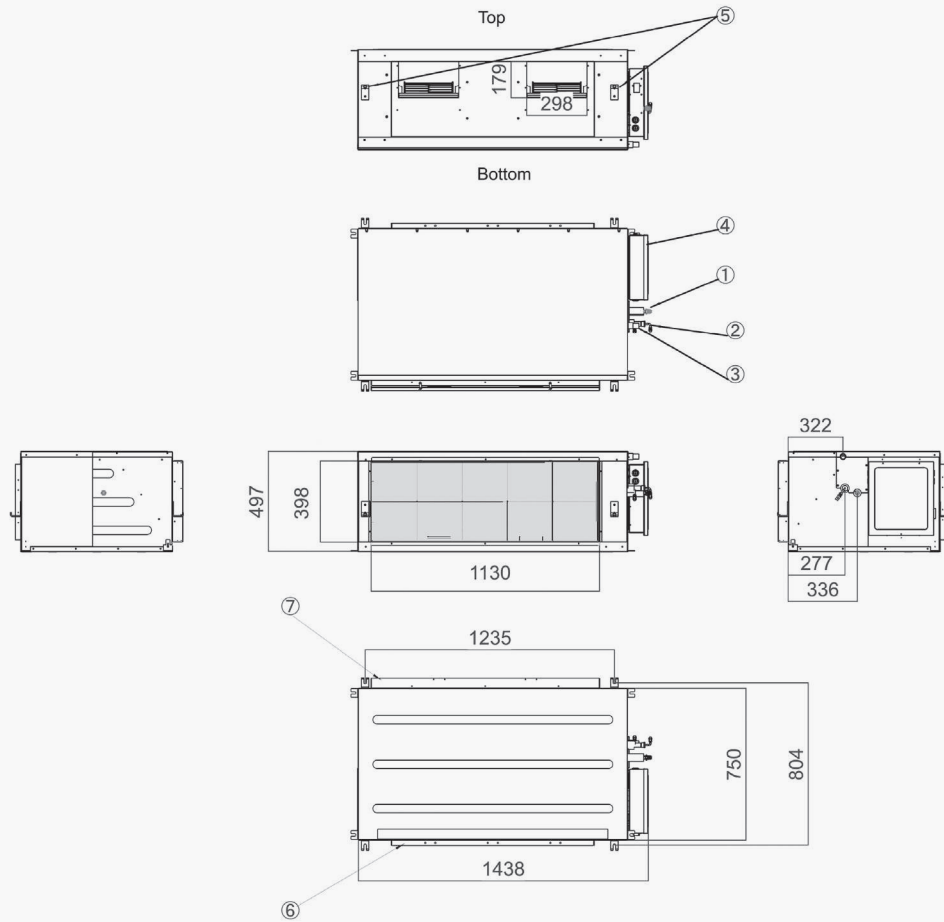

Console

IMV-015CTAREDA, IMV-022CTAREDA, IMV-028CTAREDA,
IMV-036CTAREDA, IMV-045CTAREDA, IMV-050CTAREDA

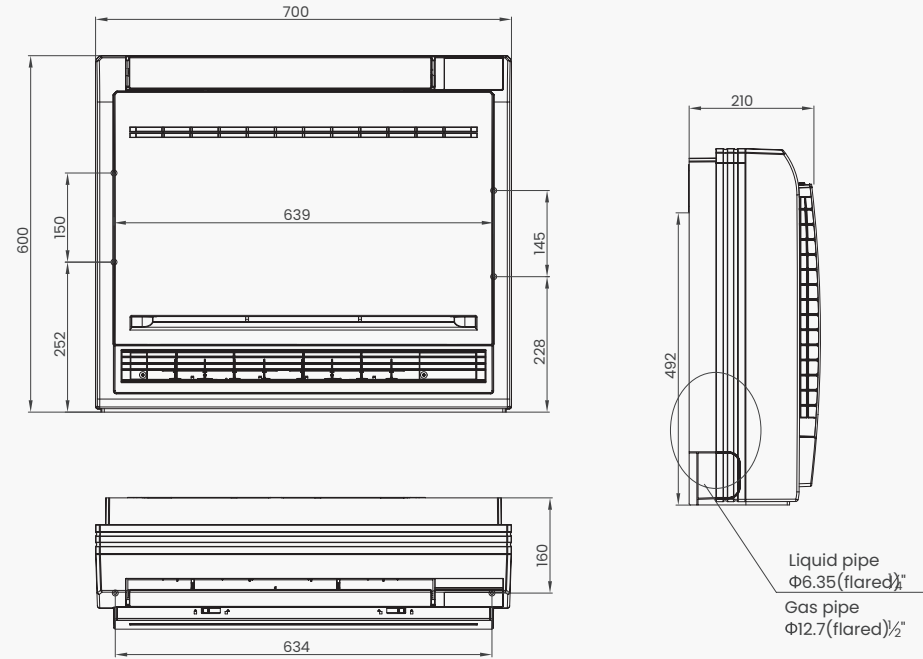

High wall

IMV-080CHAREDAV, IMV-090CHAREDAV,
IMV-080CHAREDA, IMV-090CHAREDA

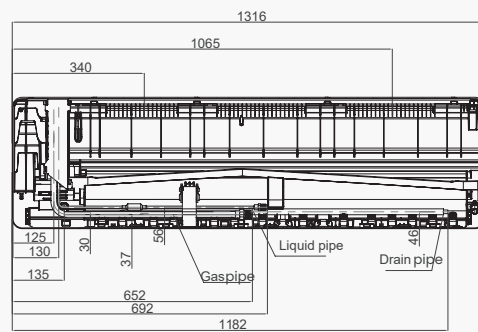
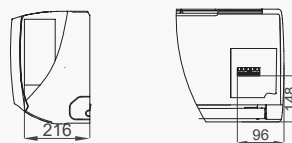
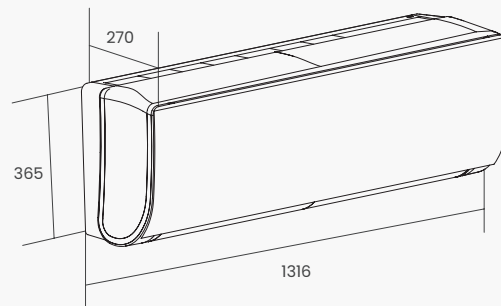

High wall

IMV-045CHAREDAV, IMV-056CHAREDAV, IMV-071CHAREDAV
IMV-045CHDAREDAV, IMV-056CHDAREDAV, IMV-071CHDAREDAV,
IMV-045CHAREDA, IMV-056CHAREDA, IMV-071CHAREDA
IMV-045CHDAREDA, IMV-056CHDAREDA, IMV-071CHDAREDA

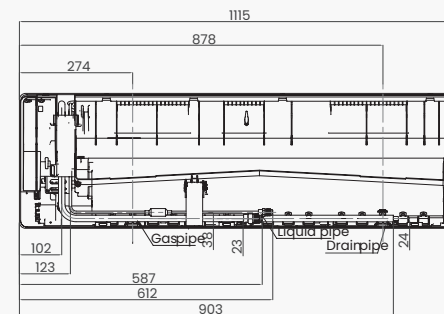
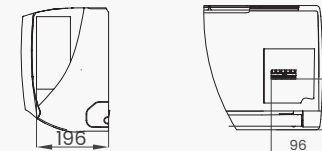
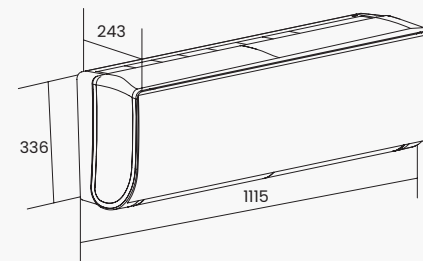

Dimensions

High wall

IMV-015CHAREDA, IMV-022CHAREDA, IMV-028CHAREDA,
 IMV-036CHAREDA, IMV-015CHDAREDA, IMV-022CHDAREDA,
 IMV-028CHDAREDA, IMV-036CHDAREDA, IMV-015CHAREDAV,
 IMV-015CHDAREDAV, IMV-022CHAREDAV, IMV-022CHDAREDAV,
 IMV-028CHAREDAV, IMV-028CHDAREDAV, IMV-036CHAREDAV,
 IMV-036CHDAREDAV

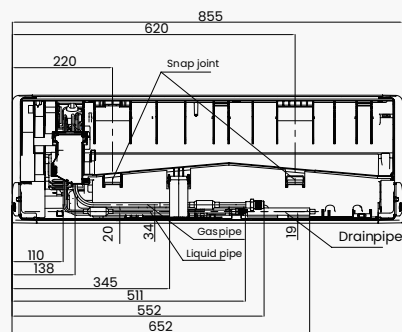
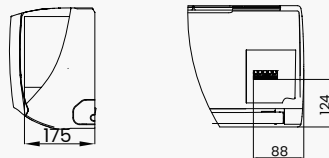
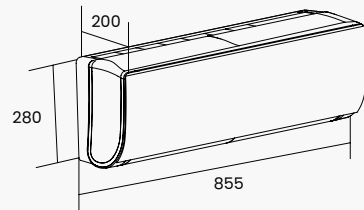

Built in Floor standing

IMV-022CTCAREAA, IMV-028CTCAREAA, IMV-036CTCAREAA, IMV-045CTCAREAA, IMV-056CTCAREAA, IMV-071CTCAREAA

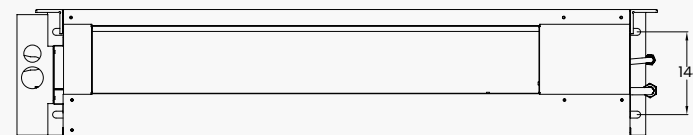
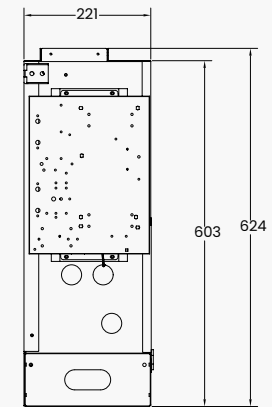
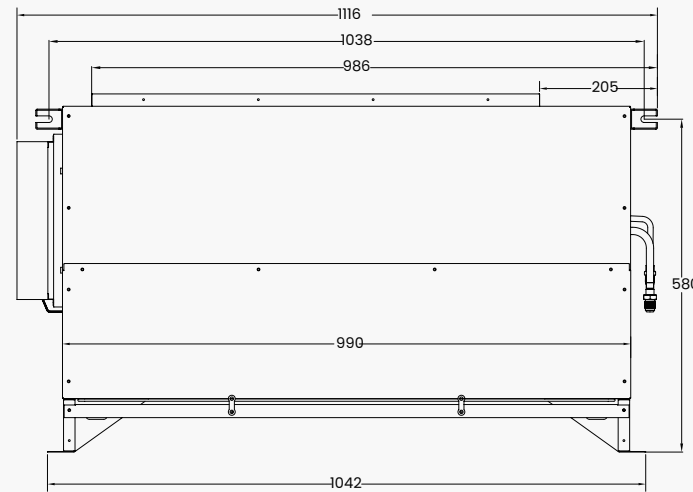

Hydro box

IMV-090HMAREW
IMV-160HMAREW
IMV-310HMAREW

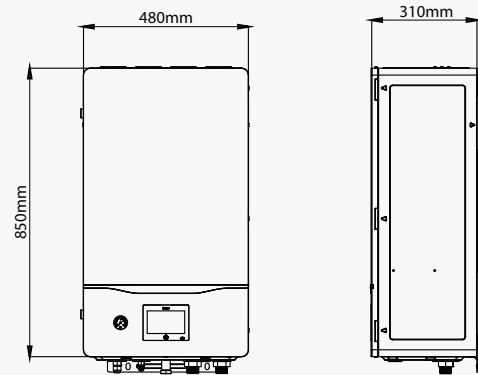

Front View

Side View

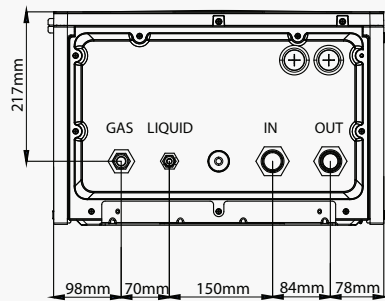

Bottom View

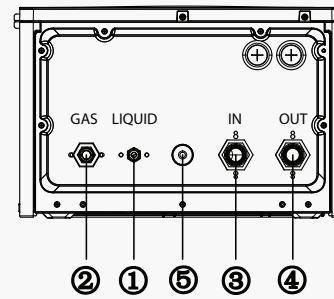

VMV Indoor ventilation

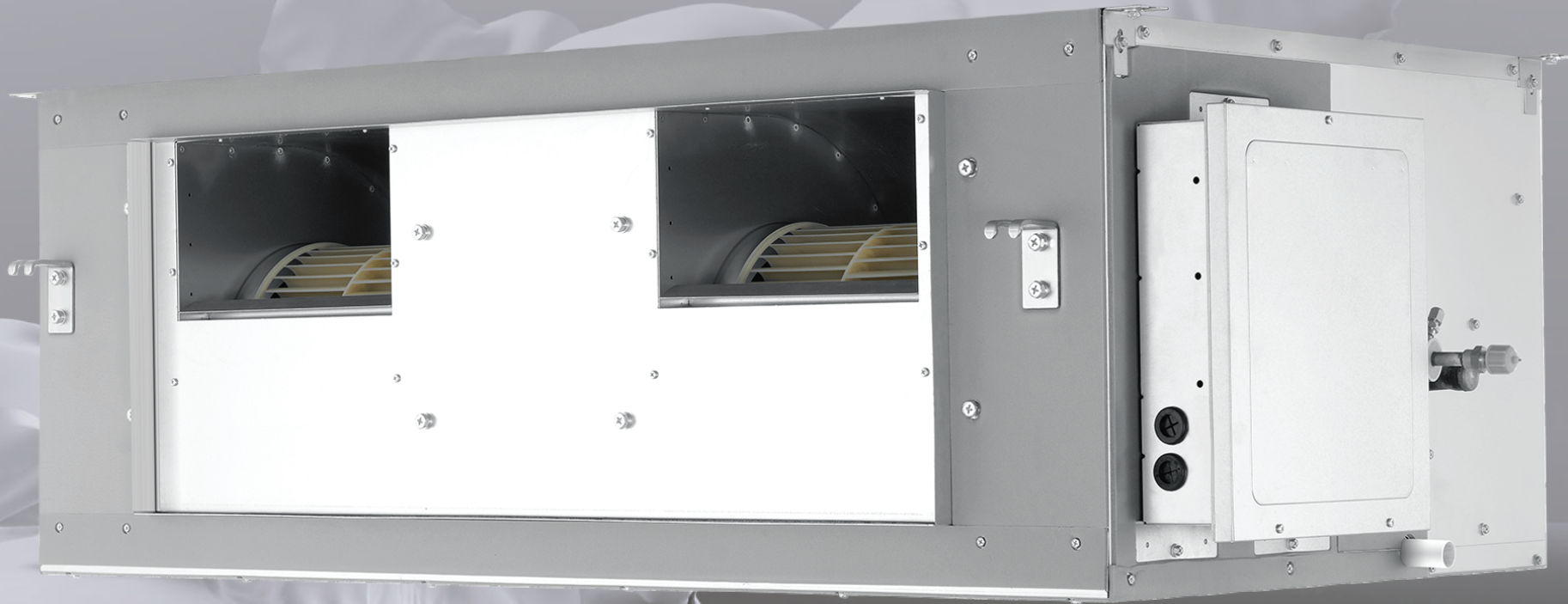

Fresh air

Perfect solution for heating, cooling and fresh air supply

VIVAX Fresh air units are ideal solution for supplying clean and fresh air to spaces where there is an increased concentration of particles such as dust or soot that interfere with the operation of classic air conditioners. These devices are suitable for installation in, for example, bakeries, restaurant kitchens and other similar facilities.

Available static pressure up to 350 Pa

VIVAX Fresh air units are equipped with a DC fan that ensures a static pressure of up to 350 Pa. This allows the unit to be installed on long ventilation duct systems.



Fresh air

Model	IMV-140FAAREDF	IMV-226FAAREDF	IMV-280FAAREDF
Power supply (PH/V/Hz)	1/220-240/50/60		
Power input (W)	240	275	370
Cooling	Capacity (kBT/h)	47.7	95.5
	Capacity (kW)	14	28.0
Heating	Capacity (kBT/h)	34.1	83.5
	Capacity (kW)	10	24.5
Air filter	Material	PP	PP
	Mesh	100	30
	Pressure drop (Pa)	5	5
Piping dimension	Gas pipe (mm)	Ø 15.88	Ø 22.22
	Liquid pipe (mm)	Ø 9.52	Ø 12.7
	Drain hose (mm)	Ø 25	Ø 25
Sound pressure level - S/H/M/L (dB(A))	48/46/44/42	48/46/44/42	49/47/45/42
Sound power level - S/H/M/L (dB(A))	61/59/57/55	61/59/57/55	62/60/58/55
Standard static pressure (Pa)	100	100	100
Max. static pressure (Pa)	200	350	350
Indoor air flow - S/H/M/L (m³/h)	1900/1600/1460/1200	2800/2300/1800/1500	3200/2800/2400/2000
Dimension - W/D/H (mm)	1500/700/248	1333/750/497	1333/750/497
Packing - W/D/H (mm)	1698/857/305	1558/896/668	1558/896/668
Net weight (kg)	45.4	88	88
Gross weight (kg)	52.6	110	110



100 - 350 Pa

Variable static pressure
100 - 350 Pa
setting



High efficiency



Fresh air



50/60 Hz

Power supply



VCW-01REA



VCW-03DREA



VCW-02CREA

Fresh air

IMV-140FAAREDF

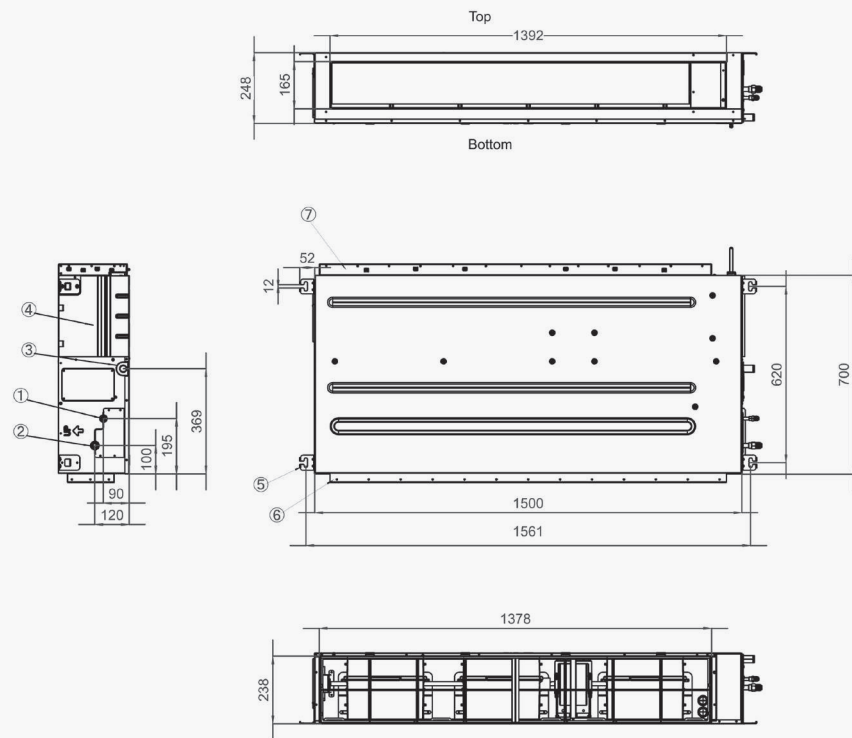

IMV-226FAAREDF, IMV-280FAAREDF

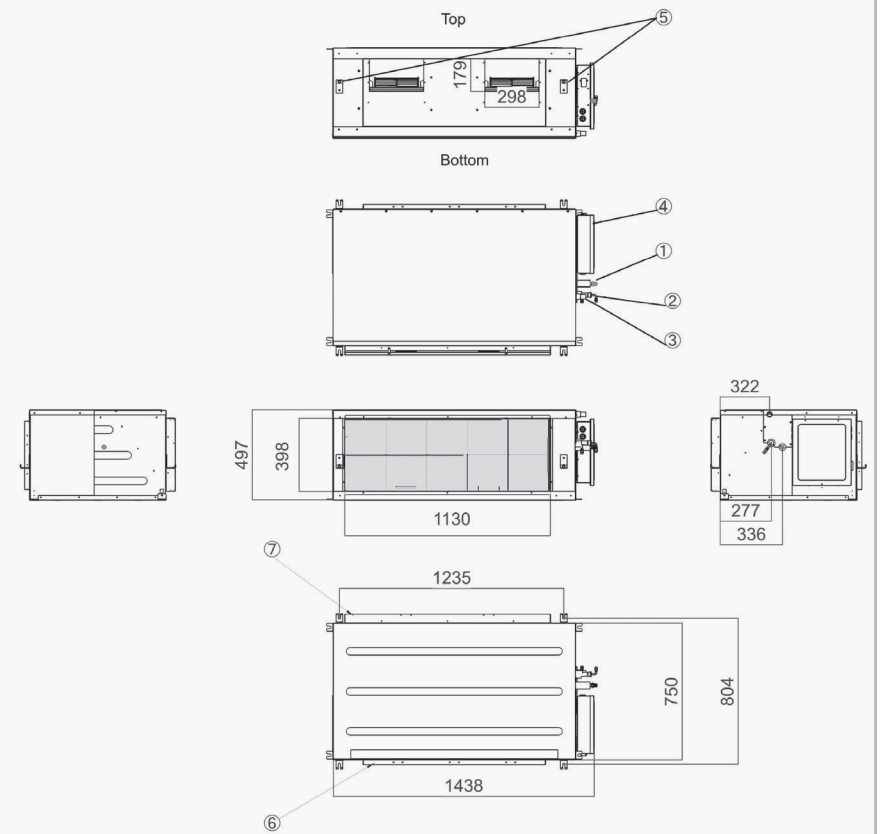







Control system



Individual Controller

The individual control system has a variety of wired and wireless controllers which enable you easy and intelligent control of your air conditioners. You can choose the one which best suits for your air conditioning management.



VCR-01CREA		<ul style="list-style-type: none"> • On/Off, Operation Mode, Fan speed, Temperature setting, Swing • Turbo and Quiet • Individual louver control for Round Flow cassette and Compact four way cassette • Clock & Timer • Health function • Self-Clean • Backlight • Convenient to operate most functions through one button
VCR-02OREA		<ul style="list-style-type: none"> • On/Off, Operation Mode, Fan speed, Temperature setting, Swing • Turbo and quiet • Individual louver control for Round Flow cassette and Compact four way cassette • Self-Clean • Timer • Health function • Backlight
VCW-01REA		<ul style="list-style-type: none"> • On/Off, Mode, Fan speed, Temperature setting, Swing • Individual & Group control (Max.16 indoor units) • Simple and Smart design, 86 x 86 x 13.05 mm • Touch button with back light • Timer/ Clock • Individual flap control for round way cassette and compact cassette • Built-in infrared signal receiver for duct units • Self-cleaning function • Built-in humidity sensor and humidity display
VCW-03DREA		<ul style="list-style-type: none"> • Individual & group control (max. 16 indoor units controllable) • Compact design 86 x 86mm • Touch screen • Black and tempered glass body with highlight LED icon display • Basic function: on/off, mode, swing, dry, auto • Built-in infrared signal receiver for infrared remote control
VCW-02CREA		<ul style="list-style-type: none"> • Colorful screen • On / off, mode, fan speed, temperature setting, swing • Individual & group control (max 16 indoor units) • Fahrenheit / celsius option; sensitivity $\pm 0.5\text{ }^{\circ}\text{C}$ ($\pm 1\text{ }^{\circ}\text{F}$) • Weekly timer • Individual louver control for Compact four way cassette and Round flow cassette • Static pressure setting
VRR-01REA		<ul style="list-style-type: none"> • Infrared signal receiver • Remote control of duct type indoor unit • Model selection depends on the duct indoor unit
VWF-C064REA (Central Control WIFI Module)		<ul style="list-style-type: none"> • Individual / Central remote control by APP • Max.64 IDUs controllable for single wifi module (Max. 256 for combinations) • Remote monitoring and control: on / off, temp, operation mode, fan speeds • Weekly Scheduling • Error alarm and error history • Convenient management authority sharing without repeating to pair with units • Connecting to 5-inch central controller (VCC-064REA); (VMV 5 and VPA-HM064REA gateway can connect directly.)

Centralized Controller

VCC-064REA

- Individual control, central control (max. 64 indoor units)
- 5-inch TFT LCD touch screen with back light
- Weekly timer
- Indoor units' information editable
- Error history
- VMV 5, VMV 5H, and VMV 5R outdoor units can connect directly, other VMV systems need VPA-HM064REA

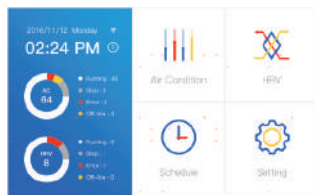

Monitoring up to 64 indoor units and monitoring the state of all IDU display IDU number, ON / OFF, Fault IDU number



Set schedule for unit, group, all time control could be add, change, delete, unit control, group control, all ON / OFF

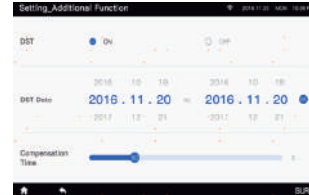

Turn ON / OFF the DST
DST schedule time setting
DST compensation setting



Display the detailed information check the name, number, temperature, running time and fault code

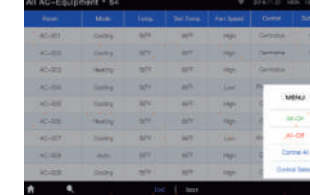

Interface display mode choice: list or icon
All on, all off, control all, control select

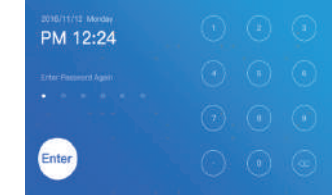

Setting password according to user demand

VCC-064REA System

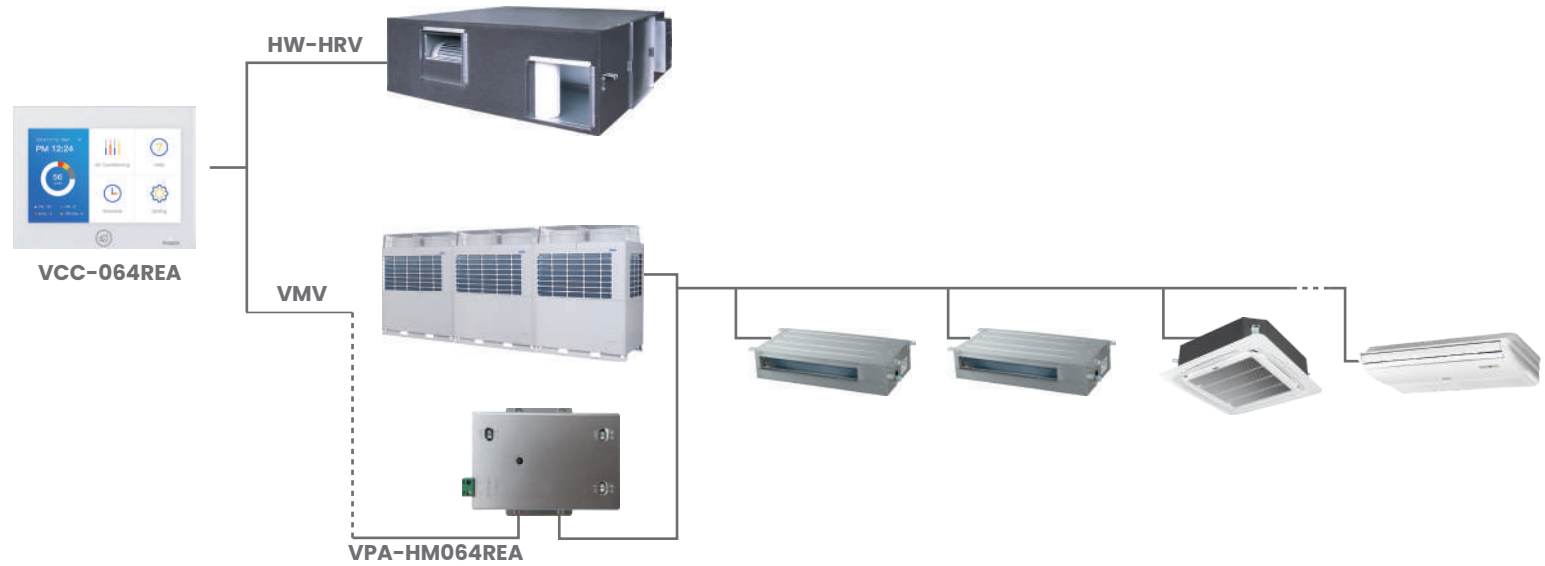

VCC-256REA

- Individual control, group control & central control (Max. 256 indoor units)
- 7-inch TFT LCD touch screen with back light
- Weekly timer
- Indoor units' information editable
- Error display
- VMV 5, VMV 5H, and VMV 5R outdoor units can connect directly, other VMV systems need VPA-HM064REA

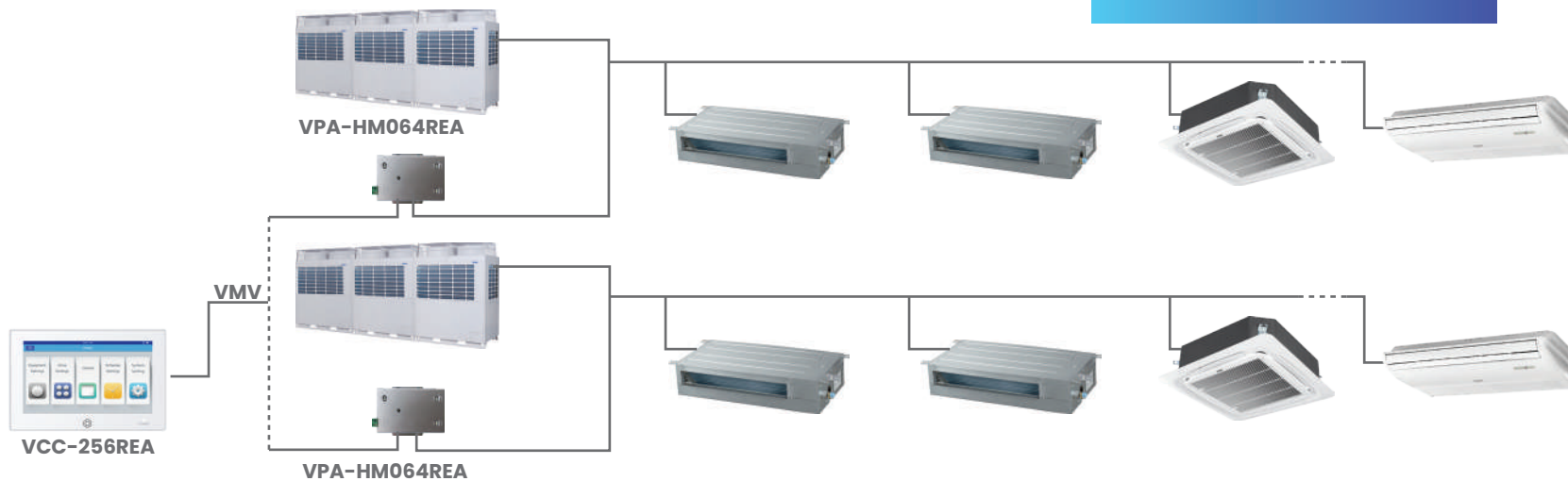
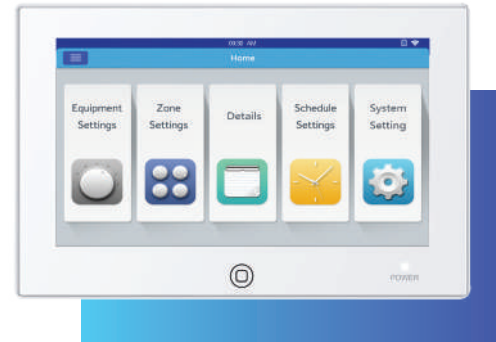

VCC-928REA

- 12.5-inch TFT LCD touch screen
- Max 800 indoor units could be connected
- Floor plan layout view
- Web Access and Email Alarm
- Weekly Schedule and Special day setting
- Integrate 3rd party devices like fire alarm, lighting with VIVAX indoor units

- All VMV system requires the new gateway VPA-MI28REA (one system requires one gateway)
- All systems require the VPA-MI28REA gateway (one per system).
- Total electricity consumption display
- Data curve
- Electricity consumption distribution for Tenant billing
- Multi Language

VCC-928REA System

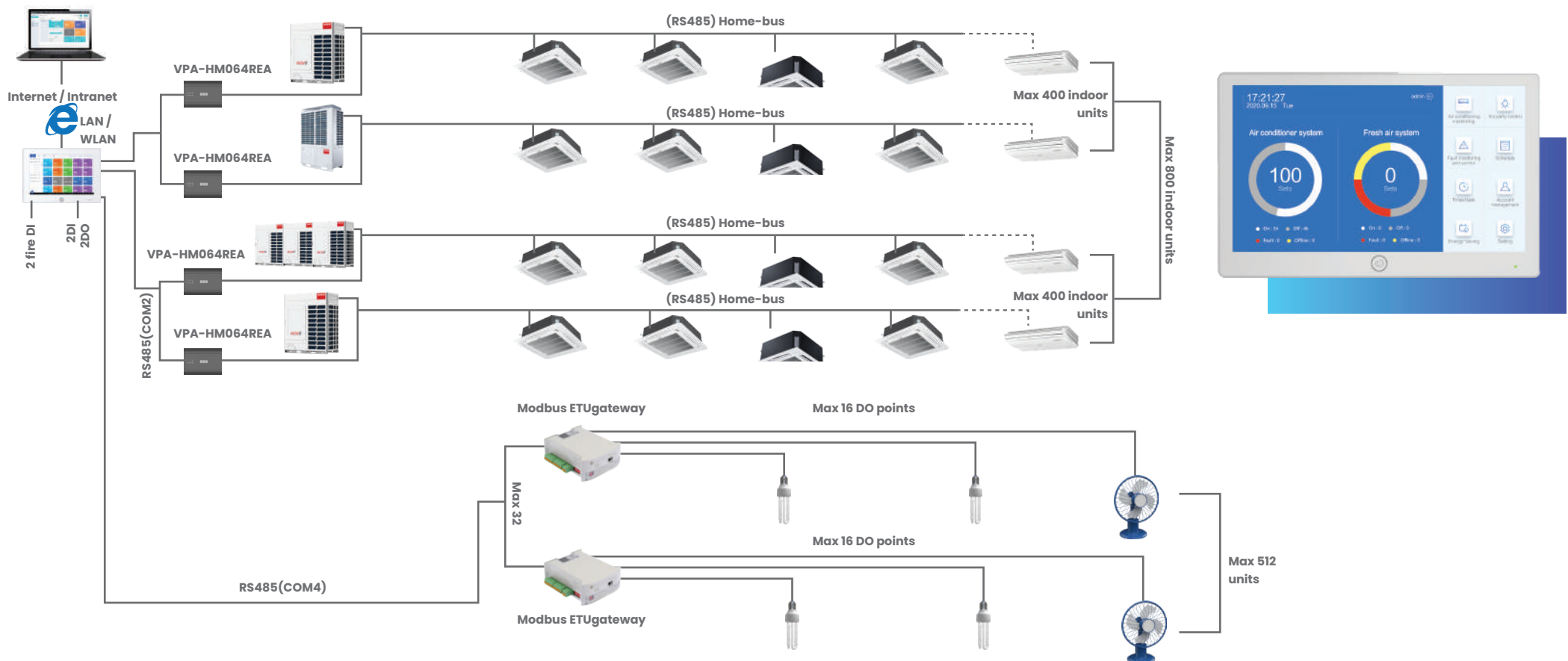

BMS Solution

The building management system modules could perfectly integrate air conditioners into the building management system, providing an excellent solution for large commercial areas.



VIVAX BMS monitor system is used to meet the demands of remote monitoring and controlling the AC systems, 3rd party BMS or BAS interface and electricity distribution management i.g the tenant billing.

VB-UM0400REA

- Local control version; convert USB to RS-485
- Max. 400 indoor units can be controlled
- Modbus rtu interface
- Brand new interface design
- Win 7 32 bits / 64 bits, Win 8 Pro, Win 10 Pro
- Max. 32 systems connectable
- VMV 5 system can directly connect with VB-UM0400REA
- Other VMV system outdoor units require VPA-HM064REA
- Electricity charge report (must use VPA-HME40REA)

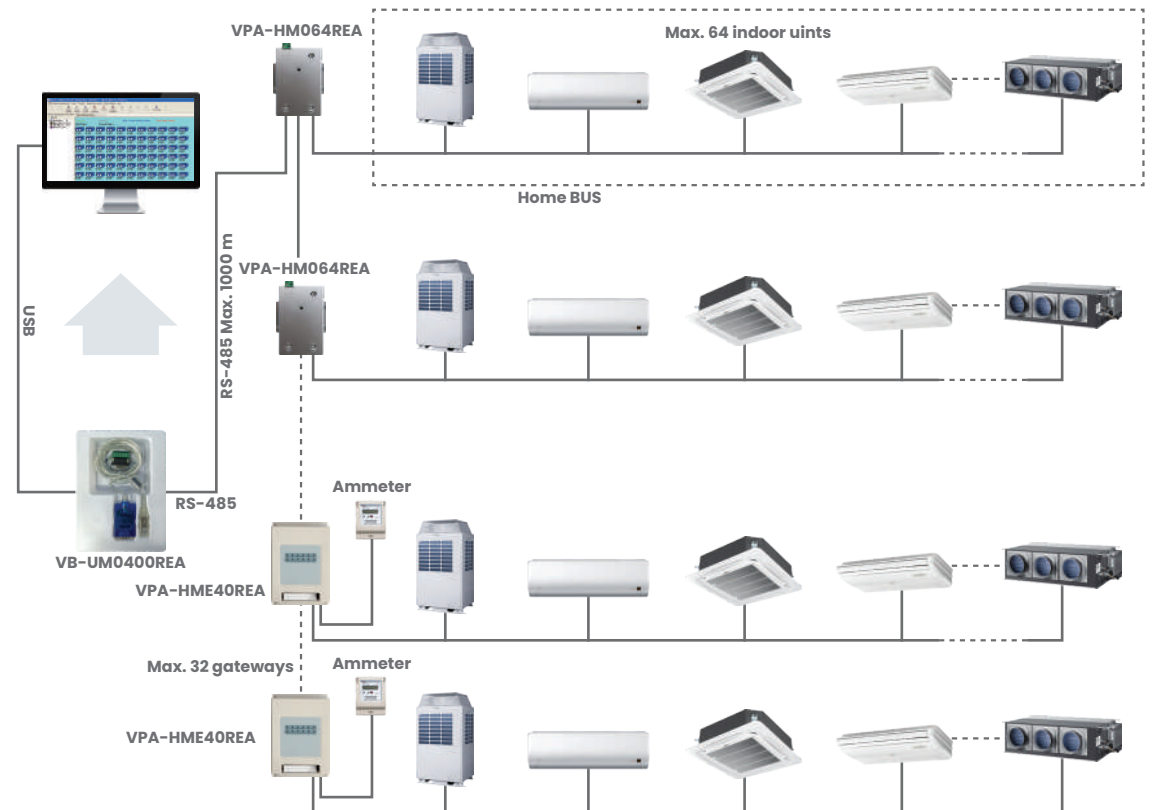

* Each outdoor system requires one VPA-HM064REA; For power consumption function, users should connect VPA-HME40REA and Ammeter.

BMS Monitor

VB-BM1500REA

- Remote monitoring version; third party interface: BACnet ip/ Modbus ip
- Max. 1500 indoor units can be controlled
- Max. 4 groups each group can connect 20 systems
- VMV 5 system outdoor units can directly connect with VB-BM1500REA
- Other VMV system outdoor units require VPA-HM064REA
- Operation status setting & monitoring.

- Schedule setting
- Multi user management with different authorized levels
- Operation and error history log
- Electricity charge report (must use VPA-HME40REA)



VB-BM1500REA System

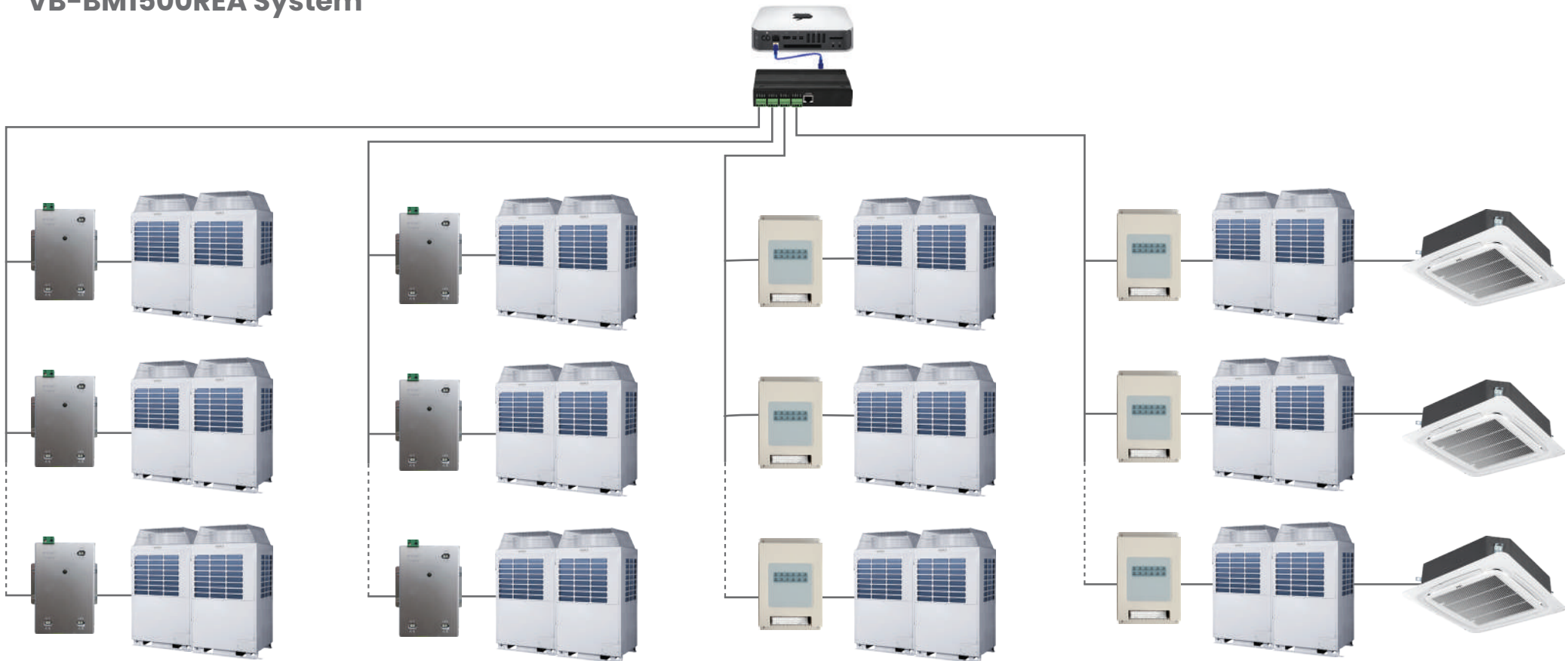



BMS interface

The adapters offer you an easy and convenient way to integrate air conditioners into various building management system; perfect for large commercial projects.

VIVAX BMS interface devices are used to connect the 3rd party BMS or BAS system, including the Modbus interface, BACnet interface and Lonworks interface etc.

VPA-HM064REA

- Protocol adapter, convert homebus to RS-485
- Gateway: modbus rtu
- Max. 64 indoor units can be connected with one VPA-HM064REA
- VMV 5 system outdoor units can directly connect with central controller VCC-064REA and VCC-256REA or BMS monitor: VB-UM0400REA and VB-BM1500REA
- Other VMV system outdoor units require VPA-HM064REA



VPA-M128REA

- Interface: Modbus
- Match with 12.5-inch webserver central controller VCC-928REA
- Max. 128 indoor units connectable
- Digital tube display Indoor quantity, gateway address, time and date
- Electricity data collection, calculation, distribution and storage



VPA-HME40REA

- Protocol adapter, convert homebus to modbus
- Electricity data collection, calculation, allocation and storage
- Match with BMS (VB-UM0400REA,03A,05,05A). each system requires one VPA-HME40REA
- Max.40 indoor units can be connected with one VPA-HME40REA



VPA-ML32REA

- Protocol adapter, convert modbus rtu to lonworks
- Each system requires one VPA-ML32REA+ VPA-HM064REA
- Max. 32 indoor units can be connected in one system
- External 24V DC power supply is needed



LonWorks System

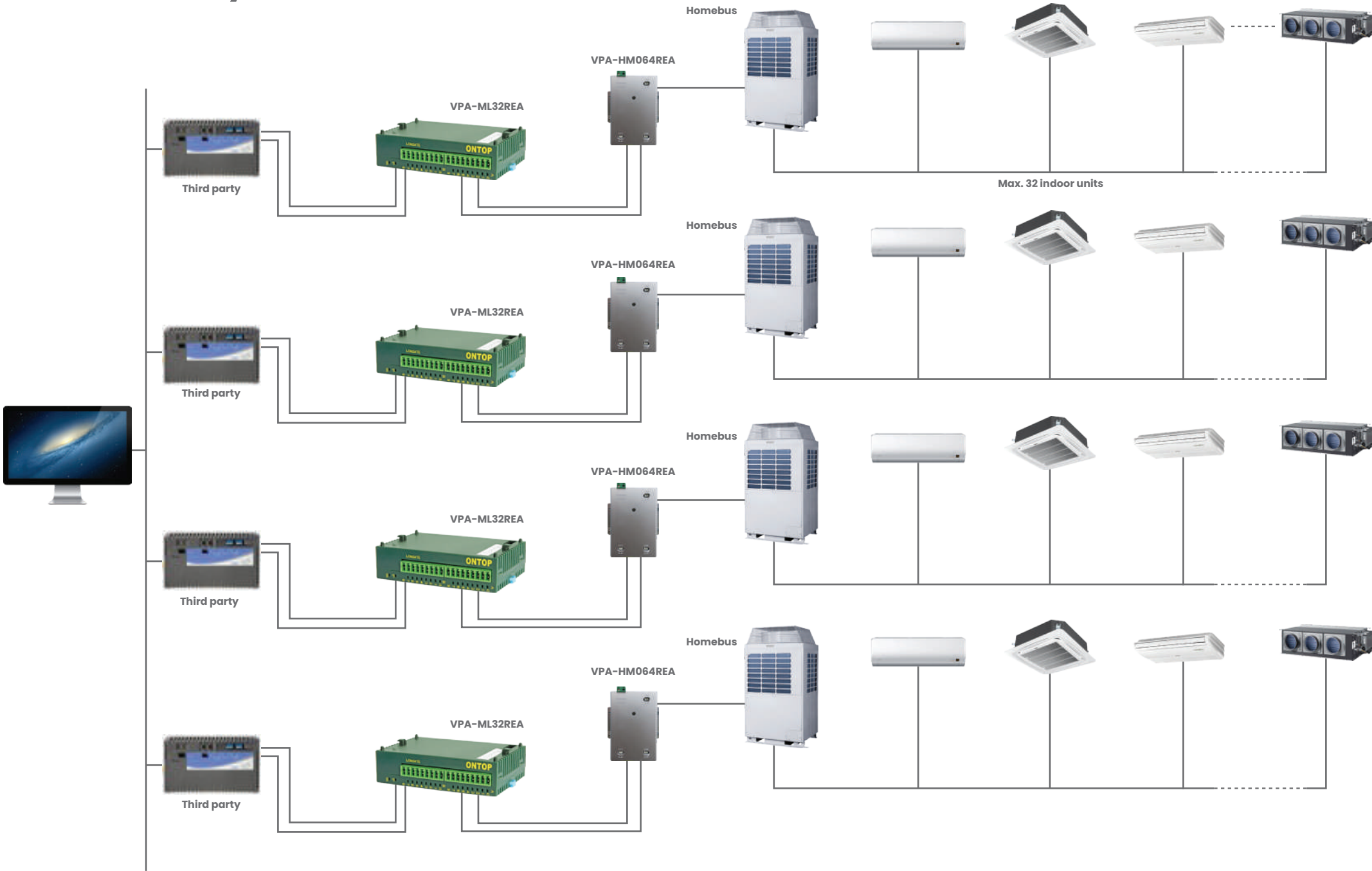

BMS interface

VPA-MB32REA

- BACnet gateway, convert modbus rtu to BACnet ip
- Max.128 indoor units / 4 systems can be controlled.
- Max. 32 indoor units for one system
- VMV 5 can connect directly with VPA-MB32REA
- Other VMV systems require VPA-HME40REA or VPA-HM064REA
- BTL certificate



VPA-MK8REA / VPA-MK16REA / VPA-MK64REA

- KNX gateway
- Convert modbus to KNX
- Max. 8 / 16/ 64 indoor units can be connected in one system
- VMV 5 can connect directly
- Other VMV systems require VPA-HM064REA



Multi tenant solution









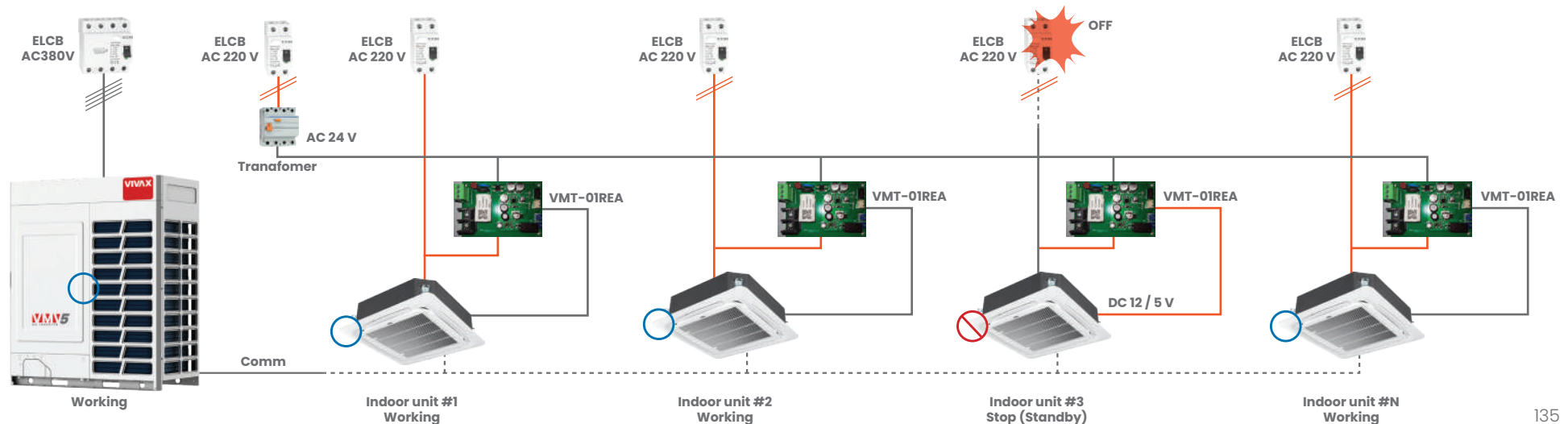

VMT-01REA

Application Scenario:

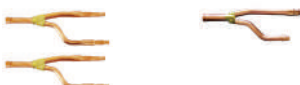
- a: The multi tenant site using separate circuit breaker for each indoor unit
- b: The hotel room using key-tag system which cuts off the power of indoor unit directly
- When it is detected that any connected indoor unit is forcibly cut off, the VMT-01REA provides DC power to the indoor PCB to ensure that the indoor unit maintains standby mode: the EEV is turned off and the control signal is blocked to prevent the system from alarming
- Note: If there is power or communication failure in the indoor computer board, VMT-01REA can not be prevented and detected



Service tool

Name	Design	Model	Functions	For what units
Gather pipe		VGP-01REA	Refrigerant gathering for VMV 5, VMV 5H	2 outdoor units
Gather pipe		VGP-02REA	Refrigerant gathering for VMV 5, VMV 5H	3 outdoor units
Gather pipe		VGP-R01REA	Refrigerant gathering for VMV 5R	2 outdoor units
Gather pipe		VGP-R02REA	Refrigerant gathering for VMV 5R	3 outdoor units
Gather pipe		VGP-R03REA	Refrigerant gathering for VMV 5R	4 outdoor units
Manifold pipe		VBP-01REA	Refrigerant distribution for heat pump VMV 5, VMV 5H, VMV S	Total indoor units capacity less than 33.500W
Manifold pipe		VBP-02REA	Refrigerant distribution for heat pump VMV 5, VMV 5H, VMV S	Total indoor units capacity less than 50.600W, but equal or bigger than 33.500W
Manifold pipe		VBP-03REA	Refrigerant distribution for heat pump VMV 5, VMV 5H, VMV S	Total indoor units capacity less than 73.000 W, but equal or bigger than 50.600 W
Manifold pipe		VBP-04REA	Refrigerant distribution for heat pump VMV 5, VMV 5H, VMV S	Total indoor units capacity less than 135.000W, but equal or bigger than 73.000 W

Name	Design	Model	Functions	For what units
Manifold pipe		VBP-05REA	Refrigerant distribution for heat pump VMV 5, VMV 5H, VMV S	Total indoor capacity less than 204.000 W but equal or bigger than 135.000 W
Manifold pipe		VBP-R01REA	Refrigerant distribution for heat recovery VMV 5R	Total indoor units capacity less than 33.500 W
Manifold pipe		VBP-R02REA	Refrigerant distribution for heat recovery VMV 5R	Total indoor units capacity less than 50.600W, but equal or bigger than 33.500 W
Manifold pipe		VBP-R03REA	Refrigerant distribution for heat recovery VMV 5R	Total indoor units capacity less than 73.000W, but equal or bigger than 50.600 W
Manifold pipe		VBP-R04REA	Refrigerant distribution for heat recovery VMV 5R	Total indoor units capacity less than 135.000 W, but equal or bigger than 73.000 W
Manifold pipe		VBP-R05REA	Refrigerant distribution for heat recovery VMV 5R	Total indoor capacity less than 204.000 W but equal or bigger than 135.000 W
VP box		VPB-01REA1, VPB-02REA1, VPB-03REA1	Valve pipe box for heat recovery VMV 5R	VMV 5R
VP box		VPB-04REA4	Valve pipe box for heat recovery VMV 5R	VMV 5R

Reference projects



Roundliner BR
Prijedor, BiH
VMV S
System capacity: 2 x 28.0 kW



Home Of Speed, Hockenheim ring
Hockenheim, Germany
VMV 5H
System capacity: 2 x 61.5 kW



Bloemen
Targoviste, Romania
VMV 5
System capacity: 45.0 kW



Links
Zagreb, Croatia
VMV S
System capacity: 22.6 kW



City Hall
Ghiroda, Romania
VMV 5
System capacity: 50.4 kW

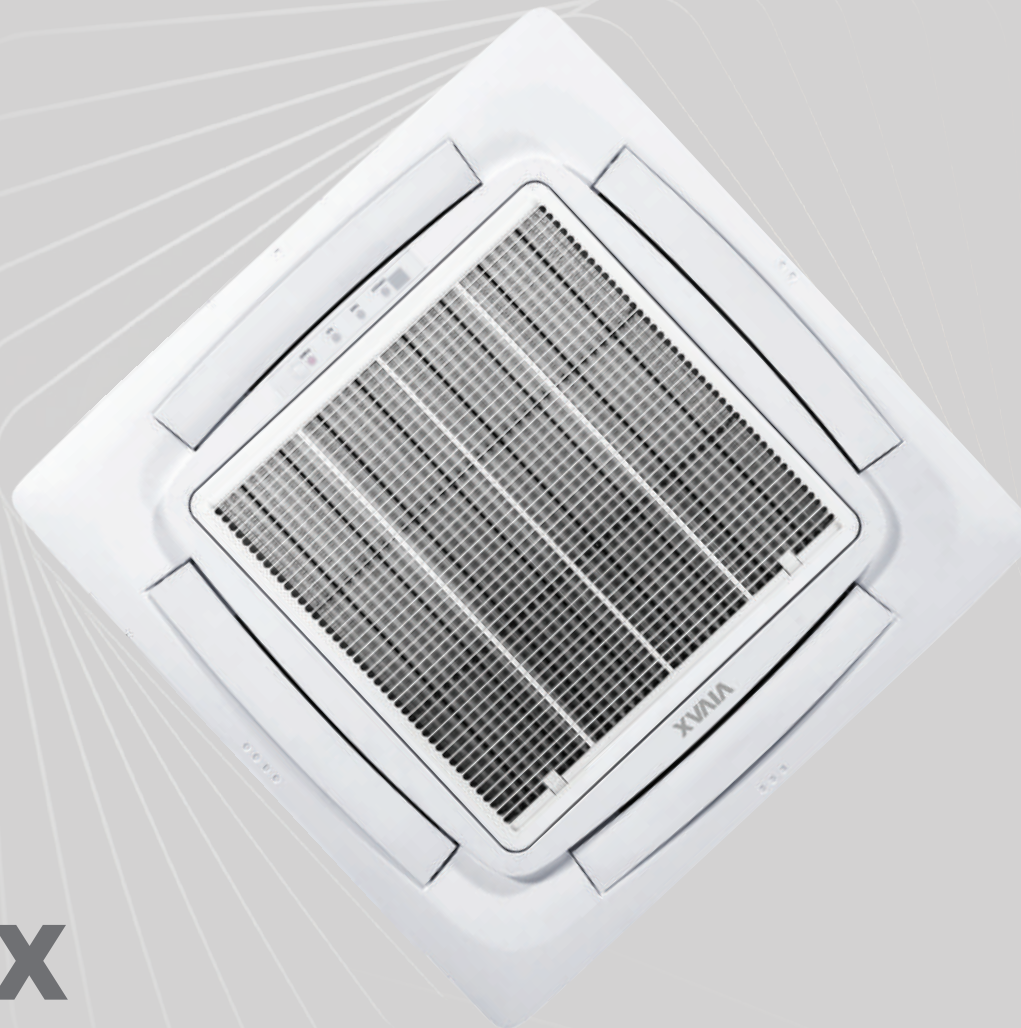

VIVAX
Simply good.

M SAN Grupa d.o.o.
Exclusive distributor for Croatia

Dugoselska ulica 5
10372 Rugvica, Croatia
t +385 1 3654 900
e vivax@msan.hr

vivax.com



VIVAX PARTNER